



GOES-R Series Concept of Operations (CONOPS)

June 2020



U.S. Department of Commerce (DOC)
National Oceanic and Atmospheric Administration (NOAA)
NOAA Satellite and Information Service (NESDIS)
National Aeronautics and Space Administration (NASA)

CHANGE RECORD PAGE

ISSUE	CCR #	DATE	SECTION/ PAGES AFFECTED	DESCRIPTION
M.M.		24 Aug 05	Pg 5	Baseline 2012 Launch
E.H.		31 Jan 07	All	Revise to Version 2
Baseline	375	2/12/07	All	CM baseline approved by the Program CCB
2.1	1087	12/05/07	Multiple	Incorporated changes requested during the Operations Project Offsite meeting
2.2	1163	02/08/08	Multiple	Capture changes in the ground segment architecture & communications services changes (EMWIN/LRIT).
2.3	1169	02/26/08	Section 5.7	Remove frequency table
2.4	1374	03/30/09	Sections 1, 1.2, 2, 3, 4.1.3.2, 4.2.1, 4.4, 4.5.1, 4.7, 5.3, 5.4, 5.5, renumbered all sections after 5.5, 5.16, 5.19; Figures 1, 7; TOC, Appendix, Glossary, Acronym	Insert RBU location; rename OSDPD Processing System to GOES-R Access Subsystem; add DOST description; included PSE representation in MOST and DOST; add GS Failover matrix; EMWIN/LRIT name change to HRIT/EMWIN; misc. corrections
2.5	1558	10/05/09	Sections 1 – 1.3, 2, 3, 4.1, 4.2, 4.3, 4.3.1, 4.3.2, 4.3.3.2, 4.3.4 (new), 4.4.4, 4.7 revised title; Figures 2 (new), 3, and 4; Tables 1, 2 (new); Renumbered all tables after table 2; Renumbered all figures after figure 2; renumbered all sections from 4.1 – 4.9.3; TOC	Correct typographical errors; revise text to reflect the current program status; add Launch Services information; update reference documents; add table, which describes the system levels of assembly; create figure, which describes the GOES-R internal and external interfaces.
2.6	1803	06/24/10	Sections 2, 4.2, 4.4 through 4.9; Figures 3, 5, 6; Table 1; renumbered numerous sections and subsections	- Correct typographical errors; revised test to reflect the current program status and architecture, added new data distribution figures and updated reference documents. - Remove reference to eGVAR and update Launch Services Program interfaces.
2.6	CMO Notes	06/24/10	Footers	Document footer is changed to “check the VSDE at https://goesv3.ndc.nasa.gov to verify correct version prior to use.”
2.7	2680A	06/06/14	Section 1.2, 2, 3, 4.2, 4.4.4, 4.6, 4.7.1.1, 4.7.1.3, 4.7.2.1, 4.7.2.2, 4.7.2.3, 4.9.1, 5.3.1, 5.5, 5.20, 6 Figures 1,3,6,7,8,9	Revised to reflect current architecture, corrected typographical errors. Corrected GOES-R interface to ESPDS/PDA, not direct interface to CLASS.
2.8	2838	10/21/14	Figures 1, 5, 6, section 4.4.4	Accuracy, current diagrams, correct LZSS utilization.

ISSUE	CCR #	DATE	SECTION/ PAGES AFFECTED	DESCRIPTION
2.9	3019A	07/08/2016	All	Removal of eGVAR, clean-up of reference documents, removal of extraneous technical scope; changed RBU to CBU
3.0	3584	06/16/2020	Numerous 1, 1.1 – 1.3, 2, 3, 4.1, 4.2, 4.3, 4.3.1, 4.3.2, 4.3.2.1, 4.3.2.6, 4.3.2.7, 4.4.2, 4.4.2.1 - 4.4.2.5, 4.4.3, 4.4.4, 4.5, 4.6, 4.6.1.1.1, 4.6.1.2.1, 4.7.2.1 – 4.7.2.3, 4.8, 4.8.2, 4.9, 4.9.1 - 4.9.4, 5.2, 5.3, 5.4, 5.5, 5.6.1.1 5.6.1.2, 5.6.1.4, 5.7, 5.8, 5.9, 5.9.6, 5.9.7, 5.9.9, 5.10.1 - 5.10.3, 5.11, 5.14, 5.14.2, 5.14.3, 5.16, 5.21 Figures 1, 2, 4, 5, 6, 8 Table 1	- Update to reflect Ground Segment updates implemented as part of the server replacement effort. - Addition of CCOR and GMAG related information
3.0	CMO	06/18/2020	CCR References Paragraph spacing Updated Acronym List	Made CCR reference formats consistent – CCR XXXX Made paragraph spacing consistent AWS, DSN, EMC, FNMOC, GRB, GEOLUTs, HPC, LV, NAVOCEANO, NECI, NMFC/JTWC, NCEP, NHC, NOS, OAR, OPC, SPC, SWFO, TPC, WFO

SIGNATURE PAGE

Prepared by:

Electronically signed by: _____ May 29, 2020

Alexander Krimchansky
GOES-R Program System Engineer

Date

Concurred by:

Electronically signed by Monica Todirita for: _____ May 15, 2020

Candace Carlisle
GOES-R Flight Project Manager

Date

Concurred by:

Electronically signed by: _____ June 11, 2020

James Valenti
GOES-R Ground Segment Project Manager

Date

Approved by:

Electronically signed by: _____ June 16, 2020

Pamela Sullivan
GOES-R Program System Program Director

Date

TABLE OF CONTENTS
GOES-R SERIES
CONCEPT OF OPERATIONS (CONOPS)

1	INTRODUCTION	1
1.1	GOALS AND OBJECTIVES.....	1
1.2	MISSION OVERVIEW	2
1.3	DOCUMENT SCOPE.....	4
2	REFERENCE DOCUMENTS (CCR 1374, CCR 1558, CCR 1803, CCR 2680A, CCR 3019A, CCR 3584).....	6
3	LEGACY SYSTEMS AND JUSTIFICATION FOR CHANGES	8
4	GOES-R SYSTEM AND INTERFACE DESCRIPTION.....	12
4.1	SYSTEM LEVEL DESCRIPTIONS (CCR 1558).....	12
4.2	GOES-R INTERFACES (CCR 1558).....	13
4.3	SPACE SEGMENT.....	15
4.3.1	GOES-R Spacecraft	15
4.3.2	GOES-R Instruments	16
4.3.3	Auxiliary Communications Payload	17
4.3.4	Launch Vehicle (CCR 1558).....	18
4.4	GROUND SEGMENT	18
4.4.1	Enterprise Management.....	19
4.4.2	Mission Management.....	19
4.4.3	Product Generation.....	21
4.4.4	Product Distribution	22
4.5	USER DESCRIPTION	23
4.5.1	User Classification	24
4.6	DATA DISTRIBUTION OVERVIEW.....	25
4.6.1	Internal Interfaces (CCR 1803).....	27
4.7	EXTERNAL DATA DISTRIBUTION (CCR 1558)	28
4.7.1	Space Based Relay (CCR 1803).....	28
4.7.2	Broadband Relay (CCR 1803)	29
4.8	SUSTAINMENT	30
4.8.1	Procurement	30
4.8.2	Ground System Refresh	31
4.8.3	Facilities Support	31
4.8.4	Management Support	31
4.9	FACILITIES.....	31
4.9.1	NOAA Satellite Operations Facility (CCR 1803).....	31
4.9.2	WCDAS	32
4.9.3	CONSOLIDATED BACKUP SITE (CCR 3019A).....	32
4.9.4	Antenna Infrastructure (CCR 1803).....	33
5	GOES-R SYSTEM OPERATIONS	34
5.1	OPERATIONAL PHILOSOPHY	34
5.2	AUTOMATION	34
5.3	TRANSITION FROM GOES-N/P	35
5.3.1	Transition timeline	35
5.4	MISSION OPERATIONS SUPPORT TEAM.....	36

5.5	Ground Readiness Team (GRT) and Product Readiness and Operations (PRO) Team	37
5.6	PHASES AND MODES OF OPERATION	38
5.6.1	PHASES	38
5.6.2	MODES	40
5.7	ORBIT DETERMINATION AND CONTROL	41
5.8	FREQUENCY UTILIZATION	41
5.9	MISSION OPERATIONS	42
5.9.1	Commanding	43
5.9.2	Telemetry Monitoring and Trending	43
5.9.3	Routine Operations	44
5.9.4	Housekeeping Operations	44
5.9.5	Special Operations	44
5.9.6	Anomaly Operations	45
5.9.7	Station Relocation	45
5.9.8	Storage Mode Activation/Reactivation	46
5.9.9	Eclipse	46
5.9.10	Flight Software	47
5.9.11	End-of-Life Decommissioning	47
5.10	INSTRUMENT OPERATIONS	47
5.10.1	ABI Operations	48
5.10.2	GLM	49
5.10.3	Space Weather and Solar Imaging	50
5.11	SCHEDULING / MISSION PLANNING	50
5.12	INSTRUMENT TASKING	51
5.12.1	Routine Instrument Tasking	51
5.12.2	Dynamic Instrument Tasking	51
5.13	FLIGHT/GROUND INTEGRATED TEST PROGRAM	52
5.13.1	Mission Operations End-To-End Tests	52
5.13.2	Special Integrated Tests	53
5.14	CALIBRATION AND VALIDATION	53
5.14.1	Pre-Launch	54
5.14.2	Post-launch Test Calibration	54
5.14.3	Routine Operations Calibration	54
5.15	IMAGE NAVIGATION AND REGISTRATION	55
5.16	ALGORITHM DEVELOPMENT PROCESS	55
5.16.1	Level 1b Algorithm Development Process	56
5.16.2	Level 2+ Algorithm Development Process	56
5.16.3	L2+ Algorithm Delivery Process	57
5.17	CONTINGENCY OPERATIONS	57
5.18	7-DAY AUTONOMY	58
5.19	CONTINUITY OF OPERATIONS	58
5.20	GROUND SOFTWARE SUPPORT	60
5.21	CONFIGURATION MANAGEMENT	61
5.22	OPERATIONS TRAINING	61
5.23	SECURITY	62
6	APPENDIX: DATA STORAGE AND ARCHIVE SUMMARY	63
7	GLOSSARY	65
8	ACRONYM LIST	68

LIST of Figures

Figure 1: GOES-R System Overview (CCR 1374, CCR 2680A, CCR 2838, CCR 3019A, CCR 3584)	3
Figure 2: Launch Through Operations Life Cycle (CCR 1558, CCR 3584)	4
Figure 3 : GOES-R Mission Interfaces (CCR 1558, CCR 1803, CCR 2680A)	13
Figure 4: GOES-R Space Segment Composition (CCR 1558, CCR 3584).....	15
Figure 5: Product Distribution (PD) and Primary External Interfaces (CCR 1558, CCR 1803, CCR 2680A, CCR 2838, CCR 3584) CCOR PD not shown here	23
Figure 6: GOES-R Data Distribution System (CCR 1558, CCR 1803, CCR 2680A, CCR 2838, CCR 3584)	26
Figure 7: GOES-R Auxiliary Communications Data Distribution System (CCR 1803, CCR 2680A)	28
Figure 8: Geostationary Satellite Observation Timeline (CCR 1558, CCR 2680A, CCR 3019A, CCR 3584)	36
Figure 9: Ground Site Failover Scenario Matrix (CCR 1374, CCR 1558, CCR 2680A).....	60

LIST of Tables

Table 1: GOES-N series vs. GOES-R series System Capabilities (CCR 1558, CCR 1803).....	10
Table 2: GOES-R Levels of Assembly (CCR 1558)	12
Table 3: Archive Summary (CCR 1374)	63

1 INTRODUCTION

The National Oceanic and Atmospheric Administration (NOAA) operates a system of Geostationary Operational Environmental Satellites (GOES) to provide continuous weather imagery and monitoring of meteorological and space environment data to protect life and property across the United States. Two GOES satellites remain operational at all times providing coverage for the eastern United States and most of the Atlantic Ocean and the western United States and Pacific Ocean basin. An on-orbit spare satellite is maintained to permit rapid recovery from a failure of either of the operational satellites. GOES satellites provide critical atmospheric, oceanic, climatic and solar and space weather products supporting weather forecasting and warnings, climatologic analysis and prediction, ecosystems management, and safe and efficient commercial and private air and marine transportation. The GOES satellites also provide a platform for solar and space environmental observations. Auxiliary communications services are provided for GOES data rebroadcast, data collection platform relay, low resolution imagery, emergency weather communications, and satellite aided search and rescue. GOES supports all of the Mission Goals and links to the National Environmental Satellite, Data, and Information Service (NESDIS) Concept of Operations (CONOPS). (CCR1558)

The GOES program currently consists of two series of satellites. The GOES-R series has assumed operational duties as both GOES-EAST and GOES-WEST while the GOES-N/P series has one satellite as an on-orbit spare. The GOES-N/P series shares the same generation primary instrument payload as its predecessor. The currently operational GOES-R series represents a generational change in both spacecraft and instrument performance. The first satellite was launched in 2016 and a second satellite launched in 2018. The increase in spacecraft and instrument performance allows for advanced and more accurate forecasting of the atmospheric, oceanic, climatic, and solar and space weather conditions. GOES-R is a collaborative development and acquisition effort between NOAA and the National Aeronautics and Space Administration (NASA). The acquisition of the end-to-end GOES-R system includes spacecraft, instruments, launch services, and all associated ground system elements. (CCR 1558, CCR 3019A, CCR 3584)

Program oversight activities occur at NESDIS Headquarters and the NASA Goddard Space Flight Center. In early 2007, the GOES-R Program established two projects; the Flight Project manages the Space Segment and the Ground Segment Project manages the Ground Segment. The Space Segment consists of the spacecraft, the instruments, launch vehicle and the auxiliary communication payloads. The Ground Segment consists of the entire ground system, which includes: the facilities; antenna sites; software and hardware for satellite command and control and to process, create, and distribute end user products; and the Consolidated Backup facility (CBU). The projects are co-located and reside within one building at the NASA Goddard Space Flight Center (GSFC). Additional information can be found at the following URL: <http://www.goes-r.gov/> (CCR 1374, CCR 1558, CCR 3019A, CCR 3584)

1.1 GOALS AND OBJECTIVES

One of NOAA's principal missions is to provide forecasts and warnings for the United States, its territories, adjacent waters and ocean area for the protection of life and property and enhancement of the national economy. The primary goals of the GOES-R series are to:

- Maintain GOES mission continuity and quality in environmental observations
- Improve services and data being provided to the users
- Protect, restore, and manage the use of coastal and ocean resources through ecosystem management approaches

- Understand both space and climate weather variability and change to enhance society's ability to plan and respond
 - Support the nations commerce with information for safe and efficient transportation
- (CCR 1558)

This mission requires the capability to acquire, process and disseminate environmental data on an extensive spatial range (global, regional and local) on a variety of time scales. These data include, but are not limited to: global imagery; cloud and precipitation parameters; atmospheric profiles of temperature, moisture, winds, aerosols, and ozone; surface conditions concerning ice, snow and vegetation; ocean parameters and sea-surface temperature; and solar and in-situ space environment conditions.

The Government is procuring the next-generation GOES series to continue its mission through new requirements specified in the GOES-R Level I Requirements Document (LIRD) and Mission Requirements Document (MRD). The objectives (as prefaced from the LIRD) of the GOES-R series are to:

- Increase lead time, accuracy and reduce false alarm rate for tornado warnings
- Increase lead time and accuracy for flash flood warnings
- Increase lead time and the accuracy of track and severity prediction of hurricanes
- Increase lead time for prediction of severe storms
- Enhance the accuracy of climatic weather prediction for the public safety of commercial and private air and marine transportation

(CCR 1558)

The first satellite of this new series, designated as GOES-R prior to launch and GOES-16 after reaching geostationary orbit, provides the first major improvement in instrument technology since GOES-I was launched in 1994. The GOES-R series has introduced other new technologies in both the Space and Ground Segments. These advances improve the nation's ability to monitor and forecast weather and environmental phenomena with a significant increase in the number of user products. (CCR 1558, CCR 3584)

1.2 MISSION OVERVIEW

The GOES-R series is the next generation of satellites within the GOES Mission. Now operational, the GOES-R series consists of two satellites at 75.2 degrees west and 137.2 degrees west longitude, respectively. The on-orbit storage location for the GOES-R series is at 105 degrees W. A general overview of the GOES-R system is given in Figure 1. (CCR 1558, CCR 3584)

The Space Segment consists of the spacecraft, instruments, auxiliary communications payloads and launch vehicle. The primary instrument is the Advanced Baseline Imager (ABI) that provides hemispheric, synoptic, and mesoscale imagery for global and CONUS forecasting and severe weather warning. Secondary instruments include the Extreme ultraviolet and X-ray Irradiance Sensor (EXIS), Solar Ultraviolet Imager (SUVI), Space Environment In-Situ Suite (SEISS), Geostationary Lightning Mapper (GLM) and either the Magnetometer (MAG) (on GOES-R/16 and GOES-S/17) or Goddard-Magnetometer (G-MAG) (on GOES-T/18 and GOES-U/19). The GOES-U spacecraft will also include the Compact Coronagraph (CCOR). Additionally, the GOES-R series provides a set of communications services (Unique Payload Services) in support of the Data Collection System (DCS), High-Rate Information Transmission/Emergency Managers Weather Information Network (HRIT/EMWIN), and

Search-and-Rescue Satellite Aided Tracking (SARSAT).(CCR 1374, CCR 1558, CCR 3019A, CCR 3584)

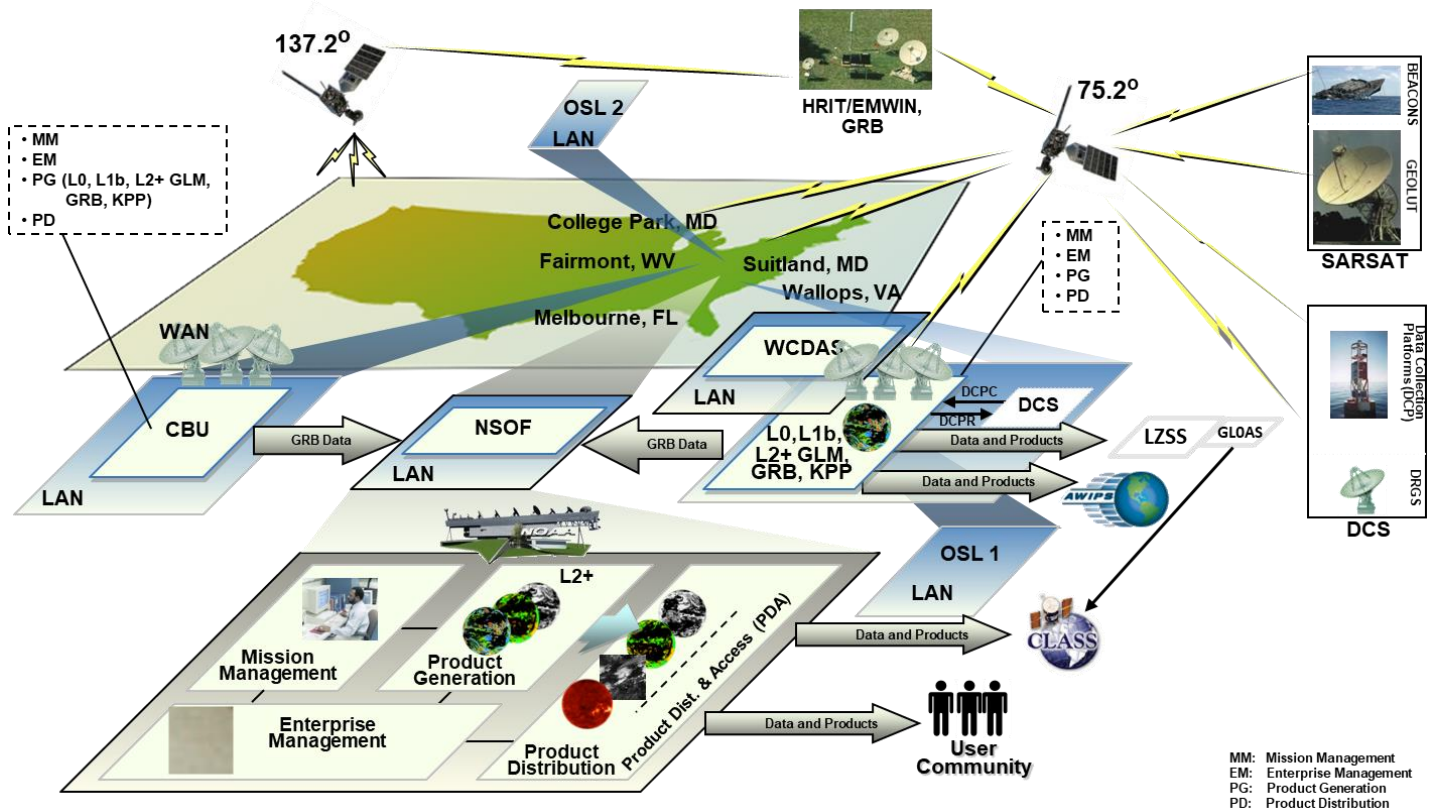

Figure 1: GOES-R System Overview (CCR 1374, CCR 2680A, CCR 2838, CCR 3019A, CCR 3584)

The NASA Kennedy Space Center (KSC) Launch Services Program performs the launch of the GOES-R series satellites; Pre-launch and launch operations are conducted by KSC Launch Services Program. The spacecraft contractor performs satellite pre-launch checkout with the assistance of each of the instrument contractors. KSC Launch Services Program personnel performs satellite encapsulation and stacking. Final pre-launch checkout is a joint effort by the KSC Launch Services Program, the spacecraft and instrument contractors, and the Ground Segment contractor to assure that end-to-end all systems are fully functional. Upon launch, the GOES-R series satellites are placed into a predetermined geosynchronous transfer orbit (GTO). The satellite is then be boosted into a geosynchronous checkout orbit for post-launch testing then relocated into a final geostationary orbit, either operational or storage. A summary of the launch through operations life cycle is shown below **Error! Reference source not found.**

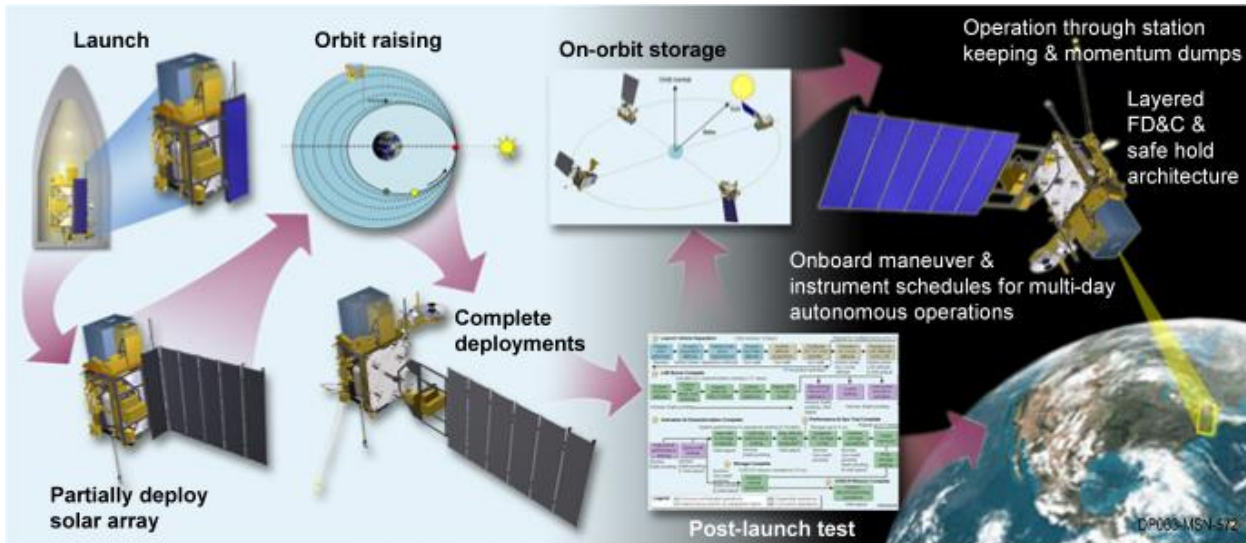

Figure 2: Launch Through Operations Life Cycle (CCR 1558, CCR 3584)

The Ground Segment (GS) operates from three sites and two Operations Support Locations (OSLs). The NOAA Satellite Operations Facility (NSOF) in Suitland, MD houses the: primary Mission Management (MM) functions of Tracking, Telemetry and Command (TT&C), the Product Generation (PG) functions of Level 2+ (L2+) product generation, and the Product Distribution (PD) of Level 2+ products. The Wallops Command and Data Acquisition Station (WCDAS) in Wallops Island Virginia provides space communications services and Level 1b (L1b) product generation. The third site is a geographically isolated Consolidated Backup Facility (CBU) located at Fairmont, WV. CBU functions as a completely independent backup for designated MM, PG and PD functions for the production and delivery of Level 1b, Key Performance Parameters (KPPs), and GOES Rebroadcast (GRB) data and is capable of remote operation from the NSOF and WCDAS. The CBU has visibility to all operational and on-orbit spare satellites. The Enterprise Management (EM) function lies over all ground segment components and locations. OSL1 is located at Melbourne, FL at Harris Rodes Factory facility, and supports system sustainment and maintenance across all GS environments. OSL2 is located in College Park, MD at the NOAA Center for Weather and Climate Prediction (NCWCP) and provides access to the product processing functions at NSOF. (CCR 1374, CCR 1558, CCR 3019A, CCR 3584)

The PD functionality provides for direct distribution of GOES-R product data to the National Weather Service (NWS) Advanced Weather Interactive Processing System (AWIPS) and the Environmental Satellite Processing Center (ESPC). The Environmental Satellite Processing and Distribution System (ESPDS), Product Distribution and Access (PDA) receives GOES-R data and distribute the data to users and to the Comprehensive Large Array-data Stewardship System (CLASS). ESPDS and CLASS receipt nodes are co-located at the NSOF. CLASS provides long-term archive and access services to retrospective users of GOES-R data. The CLASS system is considered external to the GOES-R Ground Segment and is part of the NOAA infrastructure interface. (CCR 1558) (CCR 2680A, CCR 3019A)

1.3 DOCUMENT SCOPE

The purpose of this Concept of Operations (CONOPS) document is to communicate how the GOES-R system operates, with special consideration given to user functionality and the external interfaces into

which the GOES-R system must be integrated. This CONOPS is intended as a kernel from which the ground systems contractor may derive the Ground Segment detailed requirements and design and the spacecraft contractor may develop the Spacecraft Operations Handbook (SOH). These detailed requirements (which evolved from Operations Concept (OPSCON) documents) and SOH were utilized by the GOES-R Program Office to evolve this CONOPS document. (CCR 1558, CCR 3584)

This CONOPS is not a requirements document, but it provides operational context to the Level 2 requirements defined in the MRD, and to the Level 3 requirements in the Flight and Ground Segment Functional and Performance Specifications (F&PSs) and Interface Requirements Documents (IRDs). Detailed operations plans and procedures, operations handbooks, staffing plans, and maintenance plans and procedures are developed based on the detailed system designs of each of the segments. (CCR 1558)

The CONOPS, SOH, Ground Segment detailed requirements and design have been modified throughout the Acquisition and Operations (A&O) phase of the GOES-R program. Concepts may be added or modified as functional and performance parameters of these components mature. During the A&O phase, the government has maintained the CONOPS while the A&O contractors have maintained the Ground Segment detailed requirements and design and SOH. (CCR 1558, CCR 3584)

Section 2 of the CONOPS lists reference documents. Section 3 provides background of the legacy GOES systems and justification of changes for GOES-R. Section 4 describes the GOES-R Space and Ground Segments. Section 5 gives an overview of GOES-R operations. An Appendix contains a summary of the various data archives in the system.

2 REFERENCE DOCUMENTS (CCR 1374, CCR 1558, CCR 1803, CCR 2680A, CCR 3019A, CCR 3584)

- Geostationary Operational Environmental Satellite (GOES), GOES-R Series, Level I Requirements Document, 410-R-LIRD-0137
- GOES-R Series Mission Requirements Document (MRD), 410-R-MRD-0070
- GOES-R Series Ground Segment (GS) Project Functional and Performance Specification (F&PS), 416-R-FPS-0089
- Geostationary Operational Environmental Satellite (GOES) GOES-R Series Spacecraft Functional and Performance Specification (F&PS), 417-R-PSPEC-0014
- Geostationary Operational Environmental Satellite (GOES) GOES-R Series General Interface Requirements Document (GIRD), 417-R-GIRD-0009
- GOES-R Program Plan (formerly the Management Control Plan (MCP)) 410-R-PLN-0067
- GOES-R Series Program Configuration Management Plan, 410-R-PLN-0084
- GOES-R Series Program Verification and Validation (V&V) Plan, 410-R-PLN-0083
- Calibration and Product Validation Plan Volume 1: Level 1b Data, 410-R-PLN-0101
- Calibration and Product Validation Plan Volume 2: Level 2+ Product Validation, 410-R-PLN-0194
- “Process for Limiting Orbital Debris”, NASA-STD-8719.14
- Interface Requirements Document (IRD) for the Geostationary Operational Environmental Satellite Series R (GOES-R) System Space Segment (SS) to High Rate Information Transmission Service and Emergency Managers Weather Information Network (HRIT/EMWIN), 417-R-IRD-0168
- Interface Requirements Document (IRD) for the Geostationary Operational Environmental Satellite Series R (GOES-R) System Space Segment (SS) to Data Collection System (DCS), 417-R-IRD-0005
- Interface Requirements Document (IRD) for the Geostationary Operational Environmental Satellite Series R (GOES-R) System Space Segment (SS) to GOES Re-Broadcast (GRB) Service, 417-R-IRD-0002
- Interface Requirements Document (IRD) for the Geostationary Operational Environmental Satellite Series R (GOES-R) System Space Segment (SS) to Ground Located - Command, Control and Communications Segment (GL-C3), 417-R-IRD-0001

- Interface Requirements Document (IRD) for the Geostationary Operational Environmental Satellite Series R (GOES-R) System Space Segment (SS) to Search and Rescue (SAR) Service, 417-R-IRD-0006
- Interface Requirements Document (IRD) for the Geostationary Operational Environmental Satellite-R series (GOES-R) Ground Segment and Space Weather Follow On (SWFO) Ground Segment Command and Control (C2) to Space Weather Prediction Center (SWPC) 416-R-IRD-0409
- GOES-R Ground Station Concept of Operations and Antenna System Implementation Plan, 416-R-ANTCONOPS-0205
- NASA Procedural Requirements (NPR) for Limiting Orbital Debris and Evaluating the Meteoroid Orbital Debris Environments, NPR 8715.6

3 LEGACY SYSTEMS AND JUSTIFICATION FOR CHANGES

The GOES-R series represents a generational change in geostationary meteorological observation to meet forecasting and environmental monitoring requirements in the 2016-2030 era. GOES-R products are much advanced over the GOES-I/P series in spatial, spectral, and especially temporal resolution. Radiometric and navigational accuracy of the GOES-R imagery are also significantly improved. Additional capability will be provided through the Geostationary Lightning Mapper (GLM) and enhanced solar and space weather observation instruments. The spacecraft bus design accommodates the more stringent observational requirements. Table 1 lists some specific changes from the GOES-N/P to GOES-R series. (CCR 1374, CCR 1558, CCR 3019A CCR 3584)

Space Segment

The key advancements realized by GOES-R are related to the instrument payloads and spacecraft. The advanced instruments drive improvements in the overall system, such as the processing, generation, and distribution of data products. Advances in the spacecraft improve the overall operations of the satellites and improvements in the instruments provide greater temporal resolution. (CCR 1558)

The ABI provides data products with a spatial resolution four times greater than the previous GOES-I/P series Imager in many channels (0.5 km visible, 1 km near-IR, and 2 km IR at nadir). The ABI provides provide 16 spectral channels compared to 5 channels on the current series' Imager. In addition to the increased horizontal resolution, a large focal plane detector array permits rapid scanning of Earth scenes providing very high temporal resolution. The ABI is able to complete a full-disk image within 5 minutes compared to 26 minutes for the current Imager. This improvement in temporal resolution permits the cadence of routine CONUS imaging to increase from approximately 15 minutes to 5 minutes, and rapid frames from approximately 1 minute to 30 seconds. These increases allow more comprehensive monitoring of atmospheric conditions such as aerosol concentration, cirrus cloud location, cloud properties, and yields significant improvement in severe weather forecasting. Operation of the ABI is far less complex than the previous generation Imager due to extensive automation and instrument flight software capabilities. Routine commanding of the ABI is a fraction of the legacy Imager. No special commanding for seasonal "keep-out-zones" (frames excluded because of their proximity to the Sun) are required. Star measurements occur automatically through onboard processing, as well as constraints on instrument pointing for solar and lunar intrusions during normal imaging and space scene calibrations. (CCR 1558, CCR 3584)

The Geostationary Lightning Mapper is a single-channel, near-infrared optical detector used to measure total lightning activity over the full Earth disk. GLM data are used for storm warning and now-casting. Additionally, GLM data produces a long-term database to track decadal changes in lightning activity. The Solar Ultraviolet Imager improves solar imaging temporal resolution by a factor of three, and spatial resolution by a factor of two, over the GOES-M through -P legacy solar x-ray imagers. The shift from soft x-rays to the extreme ultraviolet improves observation of the key solar phenomena of space weather. SEISS will improve observation of the radiation environment over previous GOES instruments by measuring low-energy plasma and heavy ions that cause surface charging and single-event upsets in spacecraft as well as biological hazards to human spaceflight. The CCOR, hosted only on the GOES-U, will observe the Sun's outermost atmospheric layer, the corona, providing images that are necessary to continue to accurately forecast space weather conditions. Only CCOR Level 0 (L0) data will be sent to Space Weather Prediction Center (SWPC) which will provide L0 data to the National Centers for Environmental Information (NCEI). CCOR science data processing, algorithm development,

calibration/validation is outside the scope of this GOES-R series CONOPS document. (CCR 1558, CCR 3584)

The GOES-R communication system supports the higher volume of data and services by using X-band communication links. Data handling efficiency is improved over previous missions by using Consultative Committee for Space Data Systems (CCSDS) encoding for raw instrument, telemetry, and command links. CCSDS permits diverse data types to be routed to appropriate applications without intermediate processing and delays associated with unpacking packet contents, while taking advantage of error detection and correction properties inherent in CCSDS design. (CCR 1558, CCR 3584)

A precision pointing bus is needed to meet instrument pointing and stability requirements. The GOES-R series improves on the attitude control and image navigation capability of the legacy missions. Image Navigation and Registration (INR) on GOES-R differs from the previous two series in a number of ways. GOES-R have a new allocation of INR responsibility, tighter INR performance requirements, and a new approach to achieving those requirements. As a representative metric of INR improvement, the navigation accuracy requirement for GOES I-M is 112 microradians, or 4 km at nadir. For GOES N-P, the navigation requirement is 56 microradians or (2 km) at nadir, and for GOES-R, it is 28 microradians or (1 km) at nadir. (CCR 1558, CCR 3584)

GOES-R permits a vast reduction over legacy GOES missions in instrument data collection outages due to satellite maintenance activities. Satellite “operate-through” performance for routine housekeeping such as momentum management and East/West stationkeeping maneuvers precludes the need to schedule daily or monthly outage periods. Coupled with the enhanced ABI capabilities of imaging through eclipse, the GOES-R outage goal is less than 3 hours per year compared to the hundreds of hours per year of the GOES-I/M series set. (CCR 1558, CCR 3584)

Ground Segment

To support the large increase in spatial, spectral, and temporal resolution of the ABI and other instruments, the raw data rate increased to 75Mbps, over 30 times the previous rate. GOES-R data volume drives a large increase in processing requirements for product generation and for distribution of the products to users. Product processing accounts for a much greater part of the GOES-R life cycle cost than the legacy system. (CCR 1558, CCR 3584)

The GOES-R system has a much greater product distribution capability over the legacy missions. The full set of Level 1b instrument data is provided in real time through the GRB link and the Level 2+ products are provided via network services. The Ground Segment is designed with an open and expandable architecture so that additional instrument management and data processing requirements may be accommodated without affecting existing capabilities. (CCR 1558, CCR 3584)

The incorporation of a geographically isolated backup command and control and data processing site allows the very stringent availability requirements for key products to be met, while providing a great improvement in mission continuity of operations capability. Function of the backup site at the required level requires advanced automation and enterprise management concepts.

Operational Roles

NESDIS operational organizations retain their legacy operational roles for the GOES-R Program. The Office of Satellite and Product Operations (OSPO) provides mission operations and production of Level 1b data, and support the processing and distribution of Level 1b and higher products. Algorithm development and maintenance and instrument calibration are supported by the Center for Satellite Applications and Research (STAR) with oversight by the GOES-R Program Office. Organizational roles and responsibilities are further defined in the GOES-R Program Plan (formerly the Management Control Plan) (410-R-PLN-0067). (CCR 2680A, CCR 3584)

Table 1: GOES-N series vs. GOES-R series System Capabilities (CCR 1558, CCR 1803, CCR 3584)

Function	GOES-N (legacy GOES)	GOES-R (operational GOES)
Imaging	Radiance in 5 spectral channels from 0.65 to 13.3 um	Radiance in 16 spectral channels from 0.47 to 13.3 um
	1 to 8 km spatial resolution	0.5 to 2 km spatial resolution
	26 min full disk	5 min full disk capable; otherwise 10 min FD refresh, 5 min CONUS, 30 second mesoscale
	42 urad navigation (3 sigma normal operations); 42 urad registration (3 sigma frame to frame over 90 min, normal ops)	28 urad navigation (3 sigma, normal operations); 28 urad registration (3 sigma, frame to frame, normal ops)
Sounding	Radiance in 19 channels and NWP models	Uses radiance from new imager (ABI) and NWP models
	10 km IR spatial resolution	10 km IR spatial resolution
	60 min CONUS refresh	30 minute CONUS refresh, 60 minute Full Disk refresh, 5 min mesoscale refresh
	280 urad navigation (3-sigma, normal operations); 84 urad registration (3 sigma, frame to frame over 90 min, normal operations)	140 urad navigation (3 sigma);
Solar Imaging (X-ray and EUV)	Radiance in 6 broad bands from 0.6 to 6 nm, 60 sec/image	Radiance in 6 bands, 9.4 to 30.4 nm range, 10 sec per image
Solar Imagery: Corona (CCOR on GOES-U only)	None	CCOR on GOES-U: White light imagery, 15 minute cadence, 3.7-17.0 solar radii field of view.
Solar X-Ray Flux	Flux in 2 bands from 0.05 to 0.8 nm	Flux in 2 bands from 0.05 to 0.8 nm; flare-location capability
Solar Extreme UV flux	Flux in 3 or 5 broad bands from 5 to 127 nm (N,P = 5, O =3)	Flux in reconstructed spectrum from 8 spectral bins (23 modelled) in 5- 127 nm range
Energetic Particles	Magnetospheric Protons: 80keV-800keV in 5 differential	Magnetospheric Protons: 30 eV – 30 keV in 15 log intervals

Function	GOES-N (legacy GOES)	GOES-R (operational GOES)
	channels, 330-700MeV in 3 differential channels, >700MeV integral channel Magnetospheric Electrons: 30keV-600keV in 5 differential channels Protons: 0.74MeV - >900MeV in 7 differential channels. Electrons: >0.6MeV, >2MeV, >4MeV integral channels Alpha particles: 3.8 MeV-500 MeV in 6 differential channels, 2560MeV - 3400MeV channel, > 3400MeV integral channel	and 80 keV-12 MeV in 10 log intervals Magnetospheric Electrons: 30 ev – 30 keV in 15 log intervals and 50 keV-4 MeV in 10 log intervals and 1 integral channel for > 2 MeV; Solar and Galactic Protons: 1 MeV – 500 MeV in 10 log intervals, > 500 MeV in 1 integral channel; Alphas 1 MeV/nucleon – 500 MeV/nucleon Energetic Heavy Ions: 10 MeV/nucleon - 200 MeV/nucleon in 5 log intervals
Magnetic Field	Mag Field range +/- 512 nT, 1.0 nT accuracy	Mag Field range +/- 512 nT, 2.3 nT accuracy
Lightning Event Mapper	None	10 km; >70% Probability of detection
Instrument Data Downlink	2.62 Mbps	75 Mbps per satellite max
Rebroadcast	2.11 Mbps (GVAR)	31 Mbps (GRB) per satellite
Number of Types of Products	37 (increases over time as new products are operationalized)	37 = 34 (baseline subset) +5 NOAT products – 2 (Vol Ash and HIE)
Level 1b Product	2.11 Mbps (GVAR)	31 Mbps max (0.2 TB per day per satellite compressed in data files)
Level 2+ Products	~ 50 GB per day per satellite	~ 0.3 TB per day per satellite (compressed in data files)
Planned Observational Outage	< 138 hrs/yr	< 2 hrs/yr

4 GOES-R SYSTEM AND INTERFACE DESCRIPTION

4.1 SYSTEM LEVEL DESCRIPTIONS (CCR 1558)

The GOES-R Mission is decomposed into multiple levels of assembly as described in Table 2. These definitions are used for allocating requirements in a top-down approach throughout the GOES-R series and are consistent with the terms used in the GOES-R Acronym and Glossary document 410-R-LIST-0142. (CCR 1558, CCR 3584)

Table 2: GOES-R Levels of Assembly (CCR 1558)

Level of Assembly	Name	Description
1	Mission	The Geostationary Operational Environmental Satellite series. This includes legacy, current and future GOES satellites.
2	System	The entire GOES-R satellite constellation and its supporting ground infrastructure. The system is an integrated set of segments, elements, and/or subsystems that accomplish a defined objective. The GOES-R System represents the combined Space Segment and Ground Segment capabilities.
3	Segment	A major product, service, or facility of the system. For GOES-R, Ground Segment and Space Segment are defined.
4	Element	A major grouping of Segment functional capabilities. For Space Segment, these include the spacecraft bus, instruments, and auxiliary communications. For the Ground Segment, these include Mission Management, Enterprise Management, Product Generation, and Product Distribution.
5	Subsystem	A functional subdivision of an Element consisting of two or more components. Ground Segment subsystems include the Mission Planning & Scheduling. Space Segment examples are structural, attitude control, electrical power, and communication subsystems.
6	Component or unit	A component/unit is a functional subdivision of a subsystem and generally a self-contained combination of items performing a function necessary for the subsystem's operation. Space Segment examples are electronic box, transmitter, gyro package, actuator, motor, battery. Ground Segment Component examples include antenna stations and network storage arrays.
7	Assembly	A functional subdivision of a component consisting of parts or subassemblies that perform functions necessary for the operation of the component as a whole. Space Segment examples are a power amplifier and gyroscope. Ground Segment examples include workstations and routers.
8	Sub-Assembly	A subdivision of an assembly. Space Segment examples are wire harness and loaded printed circuit boards.
9	Part	A hardware element that is not normally subject to further subdivision or disassembly without destruction of design use. Examples include resistor, integrated circuit, relay, connector, bolt, and gaskets.

4.2 GOES-R INTERFACES (CCR 1558)

GOES-R Mission interfaces are as shown in Figure 3. The diagram is meant to capture the major interfaces, which are both internal and external to the system. Brief descriptions of each interface are provided here and more detailed explanations of the functions of each are provided in the appropriate Interface Requirements Document and/or Interface Control Document. (CCR 1558)

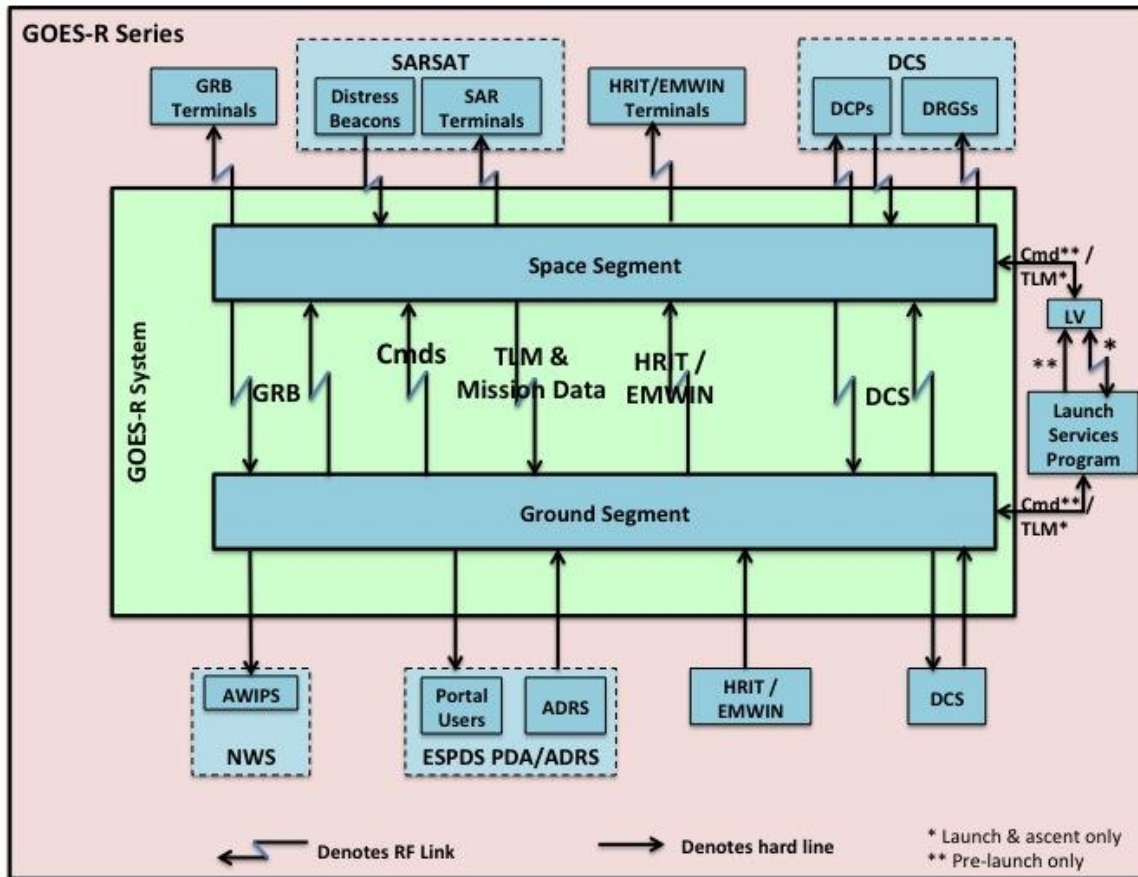

Figure 3 : GOES-R Mission Interfaces (CCR 1558, CCR 1803, CCR 2680A)

The GOES-R Mission interfaces are:

- **Commands (Cmds)** – sent to the GOES-R series satellites via direct RF communication from antennas at the WCDAS or the CBU. Commands are also sent to the spacecraft at the factory via a land line during integration and testing. During launch and orbit raising, commands are routed through the NASA Launch Services.
- **Launch Services** – Provides pre-launch processing, and communication to the GOES-R satellites during launch and orbit raising before the satellites have reached an orbital position where the GOES-R Ground System can communicate with them.
- **Telemetry (TLM)** - received from the GOES-R series satellites during nominal operations via direct RF communication from antennas at the WCDAS or the CBU. Telemetry is also received from the spacecraft at the factory via a land line during integration and testing. During launch and orbit raising, TLM is primarily received from the Launch Services network.

- Data Collection System (DCS) – DCS commands are received from the DCS facility at the WCDAS and transmitted via GOES-R antennas to the GOES-R satellites for broadcast to DCS platforms and remote ground stations. Data from the DCS platforms is uplinked to the GOES-R satellites, transmitted to the ground segment and sent to the DCS facilities at WCDAS for distribution.
- GOES-R Rebroadcast (GRB) – Level 1b processed instrument data is uplinked to the GOES-R satellites from the WCDAS or CBU facilities for broadcast to direct readout users for further processing.
- High Rate Information Transmission/Emergency Managers Weather Information Network (HRIT/EMWIN) – This data originates from either the NSOF facility or the CBU facility and is transferred to the Ground Segment for uplink to the satellites and broadcast to remote users with HRIT/EMWIN terminals.
- Ancillary Data Relay System (ADRS) - originates at the NSOF facility and provides the ancillary data necessary for the GOES-R ground system to generate the Level-2+ products.
- Product Distribution and Access (PDA) within ESPC – receives GOES-R data and supporting products for distribution to users through a portal and to the Comprehensive Large Array-data Stewardship System (CLASS). CLASS receives GOES-R data and supporting products from PDA for long-term archive and distribution.
- Advanced Weather Interactive Processing System (AWIPS) – receives GOES-R imagery data for use by the National Weather Service (NWS).
- PDA Users – These real-time watch/warning/forecast users receive GOES-R data from the ESPC.
- GRB Terminals – These terminals receive the GOES Rebroadcast data that has been re-broadcast from the space segment.
- HRIT/EMWIN Terminals – These terminals receive the HRIT/EMWIN data broadcast by the GOES-R satellites. The HRIT/EMWIN data originates at the NSOF.
- Data Collection Platforms (DCPs) – autonomous data collection platforms for monitoring of weather data which is relayed through GOES-R to the DCS system at WCDAS. These platforms can be controlled through commands relayed via the GOES-R satellites.
- DCS Remote Ground Stations (DRGSs) – These stations are recipients of the DCS data originating from the DCS platforms and re-broadcast via the GOES-R satellites.
- Distress Beacons – Devices activated by persons in distress are part of the Search and Rescue Satellite (SARSAT) service. The beacon's distress signal is transmitted via the GOES-R satellites to the SARSAT Control Center where rescue organizations are then notified and emergency responders can begin rescue operations.
- Search and Rescue (SAR) Terminals – These devices receive the SAR distress beacon signals via the GOES-R satellites.

(CCR 1558, CCR 1803, CCR 2680A, CCR 3019A, CCR 3584)

4.3 SPACE SEGMENT

The GOES-R space segment comprises the spacecraft bus, instruments, auxiliary communications payloads, and the Launch Vehicle (LV) as shown in Figure 4. The spacecraft bus supports numerous subsystems. The instrument suite consists of Earth sensing, solar imaging and space environment measurement payloads (MAG is on GOES-R/16 and GOES-S/17, G-MAG will be on GOES-T and GOES-U. CCOR is unique to GOES-U). The auxiliary communications payload contains the antennae, transmitters, receivers, and transponders to relay processed imagery data and provide the auxiliary communications services. (CCR 1558, CCR 3584)

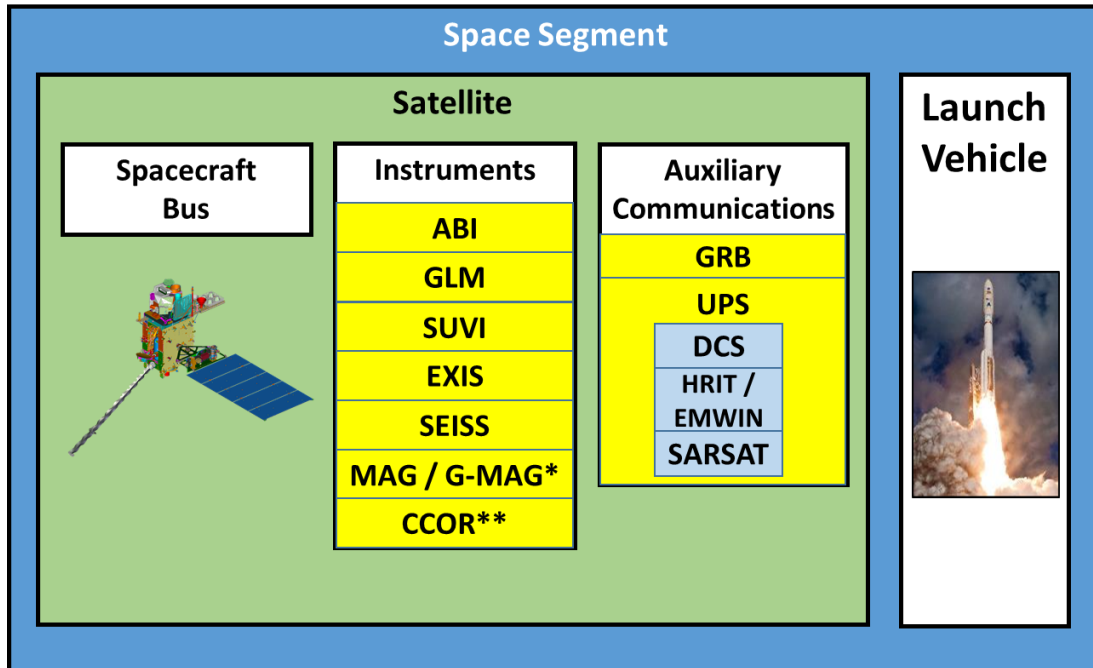

* G-MAG on GOES T & U ** CCOR on GOES-U only

Figure 4: GOES-R Space Segment Composition (CCR 1558, CCR 3584)

4.3.1 GOES-R Spacecraft

The GOES-R series spacecraft bus is 3-axis stabilized and designed for an on-orbit lifetime of 15 years: 5 years of on-orbit storage, 10 years of operational life and additionally, may be stored on the ground for up to five years. The spacecraft bus provides mechanical support and alignment of the various instrument payloads, communications payloads and other bus components. Sun-pointing instruments will be mounted on a solar array platform with an orthogonal axis gimbal to track the Sun in elevation. (CCR 1558)

The spacecraft bus will have autonomous fault detection and correction capability, enabling it to survive the occurrence of any credible single component failure or processor upset. Onboard autonomy will drive many aspects of the operational procedures. The spacecraft will be capable of executing stored command sequences and table loads that permit up to seven days of autonomous operation without ground interaction. The spacecraft bus will perform uninterrupted image data collection during station-keeping maneuvers. The spacecraft bus will have sun-positive safhold mode. The spacecraft flight

software will have telemetry points modifiable on-orbit. The flight software will be able to be uploaded without disrupting normal processor or spacecraft operations. (CCR 1558)

The spacecraft may perform a semi-annual “yaw flip” maneuver (180 deg rotation about the nadir axis). The yaw flip maneuver may increase seasonal radiometric performance. The instrument designs do not depend on a semi-annual yaw flip maneuver, although execution of semi-annual yaw flip maneuver will improve the performance of the CCOR instrument.. (CCR 1558, CCR 3584)

With an emphasis on increased operational availability, as compared to previous GOES series missions, the GOES-R series will continue to perform instrument imaging or data collection without degradation during all spacecraft housekeeping or maneuvers. Consistent with previous GOES series, the GOES-R series will not perform imaging during Yaw flip maneuvers and will recover and commence imaging within a prescribed period of time. The cumulative time that imaging is interrupted due to all momentum management and yaw flip maneuvers will be under 120 minutes/year. This is compared to 3650 minutes/year for momentum management alone on the GOES-N series. (CCR 1558)

4.3.2 GOES-R Instruments

The baseline payload suite consists of the Advanced Baseline Imager (ABI), Geostationary Lightning Mapper (GLM), Solar Ultraviolet Imager (SUVI), Extreme ultraviolet and X-ray Irradiance Sensor (EXIS), Space Environment In-Situ Suite (SEISS), Magnetometer (MAG), and Compact Coronagraph (CCOR). The following is a brief description of each instrument: (CCR 1558, CCR 3584)

4.3.2.1 ABI

The ABI is a multi-channel (visible through infrared) passive imaging radiometer designed to provide variable area imagery and radiometric information of the Earth’s surface, atmosphere and cloud cover. The ABI provides moderate spatial and spectral resolution at high temporal and radiometric resolution to monitor rapidly changing weather. ABI is designed to measure solar reflected and emissive radiance simultaneously in 16 spectral channels (as compared to 5 spectral channels in the previous GOES series). The ABI can concurrently complete a full Earth disk scan in 10 min, a Continental United States (CONUS) scan in 5 min, and a 1000 x 1000 km mesoscale scan in 30 sec. (CCR 1558, CCR 3584)

4.3.2.2 GLM

The GLM will detect the frequency and location of lightning activity. The GLM instrument will not directly produce images, but will provide event data to the ground system, which will use spacecraft telemetry, orbit and attitude information and other data to generate calibrated and navigated products mapping optical transients produced by lightning over the full disk. (CCR 1558)

4.3.2.3 SUVI

The SUVI provides narrowband imaging in the soft X-ray to EUV wavelength range at a high cadence. It replaces the previous GOES-M/P series Solar X-ray Imager (SXI) instrument and represents a change in both spectral coverage and spatial resolution over the SXI. (CCR 1558)

4.3.2.4 EXIS

The EXIS comprises two distinct instruments. The Extreme Ultraviolet Sensor (EUVS) is a full disk FOV (40 arc min) detector measuring integral solar EUV flux. The X-ray Sensor (XRS) measures the full disk integral solar X-ray flux and will monitor the duration and magnitude of X-ray flares. The EXIS and SUVI are mechanically integrated on a common Sun-pointing platform. (CCR 1558)

4.3.2.5 SEISS

The SEISS is a set of energetic particle sensors that monitor the charged particle environment at geosynchronous orbit. The SEISS consists of the Energetic Heavy Ion Sensor (EHIS), the Magnetospheric Electron and Proton Sensor-High and -Low (MPS-HI and MPS-LO) and the Solar and Galactic Proton Sensor (SGPS). (CCR 1558)

4.3.2.6 MAG / GMAG

The MAG (GOES-R/16 and S/17)/GMAG (on GOES-T&U) measures the magnitude and direction of the Earth's magnetic field in three orthogonal directions. These data provide geomagnetic variations and a map of the space environment that controls charged particle dynamics in the outer region of the magnetosphere. (CCR 1558, CCR 3584)

4.3.2.7 CCOR

The CCOR is a white-light solar telescope with an occulting disk that provides imagery of coronal mass ejections (CMEs), and is only found on the GOES-U satellite. This instrument should provide warning of significant solar related space weather events and complements other space weather monitoring capabilities of the GOES-R system. (CCR 3584)

4.3.3 Auxiliary Communications Payload

In addition to the primary environmental sensing mission, GOES-R also provides communications data relay services. The auxiliary communications payload consists of the GOES Rebroadcast service (GRB) and the Unique Payload Services (UPS) suite.

4.3.3.1 GOES Rebroadcast

The GRB service is the primary space data relay of Level 1b data products. It is the extension of the GOES-I/P series GVAR, but will include rebroadcast of at least Level 1b data from all GOES-R instruments. (CCR 1558)

4.3.3.2 Unique Payload Services

The GOES-R Unique Payload Services (UPS) suite consists of transponder payloads providing communications relay services in addition to the primary GOES mission data. The UPS suite consists of the Data Collection System (DCS), the High Rate information Transmission / Emergency Managers Weather Information Network (HRIT/EMWIN), and the Search and Rescue Satellite Aided Tracking (SARSAT). Each UPS function is performed independent of the primary GOES-R instrument payloads and associated communications links by transponders located on each of the operational (East and West) satellites. Operation of the UPS is performed from WCDAS, with backup operation from the CBU site. The sources of data and information for the UPS are external interfaces to the GOES-R system. Beyond maintaining the individual service interfaces, each UPS is essentially a “bent pipe” function to the GOES-R system. (CCR 1558, CCR 3019A)

4.3.3.2.1 DCS

The DCS is a relay system used to collect information from a large number of Earth-based platforms that transmit in-situ environmental sensor data on predefined frequencies and schedules, in response to thresholds in sensed conditions, or in response to interrogation signals. Enhancements to the DCS program during the GOES-R era include expansion in the total number of user-platform channels from 266 to 433. The GOES-R DCS system will support at least 89,000 total platforms, with a goal of

158,000 platforms. The management of DCS ground system resources is outside the responsibility of GOES-R. (CCR 1558, CCR 3019A)

4.3.3.2 HRIT/EMWIN (CCR 1374)

The Emergency Managers Weather Information Network (EMWIN) is a direct service that provides users with weather forecasts, warnings, graphics, and other information directly from the National Weather Service (NWS) in near real time. The GOES EMWIN relay service is one of a suite of methods to obtain these data and display the products on the user's personal computer. The HRIT service provides broadcast of low-resolution GOES satellite imagery data and selected products to remotely located user HRIT Terminals. This service is an evolution of the heritage Weather Facsimile (WEFAX) analog facsimile transmission. HRIT data originates from the Environmental Satellite Processing Center (ESPC) and is comprised of satellite imagery and derived products from GOES and Polar programs; watches, warnings, forecasts, graphics, and other hydrometeorological products originating in the National Weather Service; and products derived from DCS data. (CCR 1374, CCR 1558)

The EMWIN and HRIT data products will be combined into a single data stream prior to uplink and broadcast through the GOES-R series satellites. Users will receive the signal through a common receiver and decode products based on their specific needs. (CCR 1374, CCR 3019A)

4.3.3.3 SARSAT

The SARSAT transponder relays emergency beacon signals from marine, aircraft, or individuals in distress to Geostationary Earth Orbit Local User Terminals (GEOLUTs) in the Cosmicheskaya Sistyema Poiska Avariynich Sudov (Space System for the Search of Vessels in Distress) (Cospas)-SARSAT system. Each GOES-R satellite employs an Earth coverage antenna for reception of the uplink 406 MHz SAR beacon signals and another Earth coverage antenna to provide a downlink L-Band relay to the ground support GEOLUTs. The SARSAT service requires only monitoring by the GOES-R ground system. (CCR 1558)

4.3.4 Launch Vehicle (CCR 1558)

The LV that will place the GOES-R series satellites into the pre-determined geosynchronous orbit will be an EELV class. The satellite/LV integration will be performed at the launch site and the spacecraft, instrument, and launch vehicle contractors will be present and involved. Prior to the satellite/LV integration, the LV will be stacked and placed on the launch pad by the LV contractor. The LV contractor will integrate the satellite onto the LV and final functional checkout of the satellite will be performed just prior to the fairing. (CCR 1558)

During the launch and ascent phase, the satellite communications will be through the LV RF systems. During the GTO phase, the satellite communications will be through the Deep Space Network (DSN). Once the satellite is placed into the checkout location and Post Launch Testing (PLT) begins, the satellite communications will be through the GOES-R Ground Segment. (CCR 1558, CCR 1803)

4.4 GROUND SEGMENT

The GOES-R Ground Segment (GS) comprises four functional categories: Mission Management, Product Generation, Product Distribution, and Enterprise Management. These categories have been defined as a basis for grouping functional attributes of the GS, and are not necessarily intended to specify an implementation of the system. Additional interface and support functions are included within the GS. The GS elements encompass the hardware/software systems and set of processes to accomplish

mission operations. The following sections describe the operational elements of the GS functional architecture.
(CCR 1803)

4.4.1 Enterprise Management

Enterprise Management (EM) supports all operational functions by supervising the elements that comprise the operational systems and networks for the GOES-R GS. In the EM context, supervision is defined as the ability to monitor, report, and provide capability for an operator response to anomalous conditions. EM functions underpin the infrastructure that links the MM, PG, and PD functions and supports automation. While direct control of various systems may be implemented within the individual elements, EM provides a high-level layer of supervision over the end-to-end GS. GS operators at all sites have access to the EM functionality for insight to their local site and to the distributed GS components, infrastructure, and interfaces. As the EM functionality receives status and other information provided by the distributed GS functions, operators would be able to monitor, trend, and perform other supervisory activities. Some specific functions and capabilities of EM are: (CCR 1803)

- Monitor and report the end-to-end status and performance of all GS system elements (hardware and software), networks, communication links and antennae operations
- Provide real time textual and graphical display of system performance and status
- Allow the status of the entire GS to be continuously available for monitoring from any site
- Supervise all GS networks and interfaces to external systems
- Provide support to network and system performance metering
- Supervise all primary and backup site functions
- Supervise all hardware and software configurations associated with the GS networks
- Supervise the configuration of all support and test networks
- Provide an interface to incident reporting and status (e.g., service desk and trouble-tickets)
- Supervise GOES-R Product Distribution
- Supervise IT enterprise security
- Supervise remote access to satellite and product performance data

(CCR 1803)

The EM function is a primary tool of real time operators and engineers to provide greater operational availability, efficiency, and safety of the GOES-R system. (CCR 1803)

4.4.2 Mission Management

Mission Management (MM) encompasses all operational functions of the spacecraft and instruments. These functions include: (CCR 1803, CCR 3584)

- Space-Ground communications (uplink & downlink), including GRB relay
- Command generation and telemetry data processing
- Raw (instrument) data processing through Level 0
- Mission operations (includes real-time console operations, offline engineering and trending, bus and instrument health and safety and performance monitoring, anomaly detection & resolution,

procedure development, spacecraft resource accounting, special operations planning & execution)

- Unique payload services and GOES-Rebroadcast (GRB) monitoring
- Mission scheduling and planning
- Orbit determination and maneuver planning (including co-location and collision avoidance maneuvers)
- Image Navigation and Registration monitoring operations
- Flight Software (FSW) management
- Routine instrument calibration support and Product Monitoring
- Instrument raw data temporary storage
- Spacecraft telemetry data archive and remote access to telemetry
- Conformity to NASA Procedural Requirements for Limiting Orbital Debris (NPR 8715.6)

(CCR 1803)

Some specific features of the MM function are elaborated below. More details on the MM function are presented in section 5. (CCR 1803)

4.4.2.1 Remote Access

The MM function includes remote access to spacecraft and instrument engineering telemetry for anomaly resolution and assessment of satellite, instrument and product performance by off-site personnel. Remote access includes retrieval of historical data as well as real time streaming of selected satellite telemetry data. (CCR 3584)

4.4.2.2 Engineering Telemetry Data Archive and Analysis System

MM archives all engineering telemetry data for the life of the GOES-R Program. This function includes normal database functions, allowing engineers to access the archive, search for needed data, retrieve data, and perform trending analysis. The database and archive is managed by the EM function and maintained by the sustaining engineering function for the life of the program. (CCR 1803, CCR 3584)

4.4.2.3 Raw Data Revolving Temporary Storage (CCR 1803)

MM functionality at both WCDAS and the CBU stores all instrument raw data CCSDS Transfer Frames for 5 days. The temporary storage makes raw data available for diagnostic purposes in case engineering needs to troubleshoot an instrument or ground system problem with the data. The raw data archive may also support special research requests from elements within or closely associated with the GOES-R program. The raw data temporary storage is not intended as a backup for routine reprocessing of products by the PG function or to provide archive and access functionality through the PD. (CCR 1803, CCR 3019A, CCR 3584)

4.4.2.4 Satellite Simulator

A high-fidelity satellite simulator serves as the backbone for mission operations support. The simulator incorporates attitude and orbit dynamics models giving full environmental context and driving the attitude control, power, and thermal models with orbit- and attitude-dependent functionality. The simulator interfaces with the MM command and control system at baseband through software adaptors and directly through the Intermediate Frequency (IF) ground equipment path. A flight processor within

the simulator executes actual flight software code. It also provides functional models of the instruments. (CCR 1803, CCR 3584)

The satellite simulator fulfills the following critical mission operations functions:

- Enable the Verification of the MM satellite command structure and format
 - Telemetry & Command database validation
 - Flight operations procedure development and validation (routine and contingency)
 - Mission operations training & Sequence of Event (SOE) rehearsals (routine and contingency)
 - Ground System End-To-End testing
 - Mission operations command generation verification
 - Instrument operations scenario validation
- (CCR 1803, CCR 3584)

Satellite simulators will be located at all three locations, the WCDAS, the NSOF and the CBU to provide full operational continuity across sites. (CCR 1803, CCR 3019A)

4.4.2.5 Product Monitor

A key component of the MM functionality is a Product Monitor (PM) system capable of displaying Level 1b instrument data received or transmitted as GRB. The PM serves as the principal product quality monitoring tool for real time operations personnel, effectively reproducing the environment of a typical GRB user while incorporating additional features such as automated evaluation of GRB signal quality. The PM is also be capable of displaying instrument Level 1b source data to real time operators. PM function is be provided for all the instruments with a little more sophistication for the ABI and SUVI. (CCR 1803, CCR 3584)

Radiometric performance and image navigation monitoring in the ABI, GLM, and SUVI Level 1b product are performed as part of the PM function. The PM may provide automated processing of imagery required for INR or for quality assessment of INR for the ABI and GLM (e.g. implementing landmarking algorithms for geolocation of instrument pixels). (CCR 1803, CCR 3584)

4.4.3 Product Generation

The Product Generation function creates Level 1b and Level 2+ products for the full GOES-R core product set, listed in the GS F&PS Appendix A. The core product set consists of Level 2+ (L2+) products and includes the ABI cloud and moisture imagery products key to the protection of life and property, designated as Key Performance Parameters (KPPs). Product Generation operates on a continuous basis, meeting latency and availability requirements. PG also creates the GRB data set for transmission to GOES-West and GOES-East for rebroadcast via the satellite to direct readout users and for transmission via terrestrial comm to the NOAA Satellite Operations Facility (NSOF) for the generation of the L2+ data products. The GOES Program is not responsible for product generation for the CCOR instrument on GOES-U. Product Generation for all other instruments includes the following functions: (CCR 1803, CCR 3584)

- Produce Level 1b products from Level 0 data provided by MM
- Perform radiometric calibration and geometric correction
- Maintain calibration database

- Generate L2+ products from algorithms and ancillary data
- Assemble GRB data sets, from Level 1b products, for rebroadcast and terrestrial transmission
- Monitor radiometric and INR performance
- Maintain the Product Generation test capability for product verification and validation and algorithm testing

(CCR 1803)

4.4.4 Product Distribution

The Product Distribution (PD) function provides distribution of Level 0, Level 1b, GRB, Level 2+, and associated mission data produced by PG. PD functionality spans each of the three ground segment locations. The PD includes the following functions: (CCR 1803, CCR 3584)

- Send data and products received from PG to the NWS/AWIPS interface
- Send data and products received from PG to the PDA (CCR 1374)
- Make available data and products through the PDA for authorized users
- Store 7 days of data and products after product generation for redistribution
- Send level 1b and L2+ products, ancillary data, and associated metadata to the GOES-R Access Subsystem (GAS) (Note: The GAS functionality is performed as part of the ESPDS PDA located at NSOF). The ESPDS PDA distributes the data to users through the portal and to CLASS for long-term storage and archiving.
- Distribute the GRB data stream to MM for RF transmission
- Distribute L0 CCOR data to SWPC for further processing
- Distribute the GRB data stream by Wide Area Network (WAN) between GS sites

(CCR 1803, CCR 2680A, CCR 3019A, CCR 3584)

PD is responsible for any reformatting, reprojection, subsetting (sectorizing), and routing for distribution to the AWIPS interface. AWIPS data is routed to the National Weather Service primary site in Silver Spring, MD and their backup site in Fairmont, WV. (CCR 3584)

The PDA contains the GOES-R end user interface which is the operational user interface for ad-hoc data queries and for establishing or modifying data subscriptions or standing orders for machine to machine delivery of data via “push” or “pull” distribution. The PDA makes available the 7-day temporary storage and the GOES-R core product set which are the level 2+ products. All users accessing data via the PDA draw their data from the 7-day temporary data store. The 7-day temporary storage serves as the short-term access for fulfillment of ad hoc user requests for recent historical data. The Office of Satellite Ground Services (OSGS) has an interest in moving to an enterprise-wide solution for all NOAA missions and will lead the development of this part of the PD element. (CCR 1374, CCR 1803, CCR 2680A, CCR 3019A)

Other data distribution systems that provide GOES data and products to users exist outside of the GOES-R program. These systems interface with GOES-R through the PDA, however they may require modifications in order to receive and redistribute GOES-R data and products. These systems include, but are not limited to: the NWS’s NOAAPORT and the NWS Data Delivery Project. Product Distribution via publicly accessible networks allows some users with less stringent data continuity requirements to receive Level 1b data without investing in Earth station GRB receive systems. Figure 5

shows the primary Product Distribution and external interfaces. (CCR 1374, CCR 1558, CCR 1803, CCR 3019A, CCR 3584)

Note regarding Level 0 (L0) data:

The GOES-R satellite L0 data are made available at WCDAS via the Level Zero Storage Service (LZSS). LZSS is a repository that temporarily stores and provides access to L0 data. L0 data that GS PD sends to the LZSS are kept in the same format (i.e. file type, naming convention, etc.) as the delivery mechanism from the Core. CCOR science data processing, algorithm development, calibration/validation is outside of the scope of this CONOPS. (CCR 2680A, CCR 2838, CCR 3584)

Deployed at WCDAS but outside GS Core, LZSS leverages secure key exchange for authentication and authorization methods to allow access to the LZSS. The LZSS is used primarily by instrument and CAL/VAL teams. If these users need to keep certain data for a longer period of time, it is be their responsibility to retrieve and store that data on their system. (CCR 2680A, CCR 2838, CCR 3584)

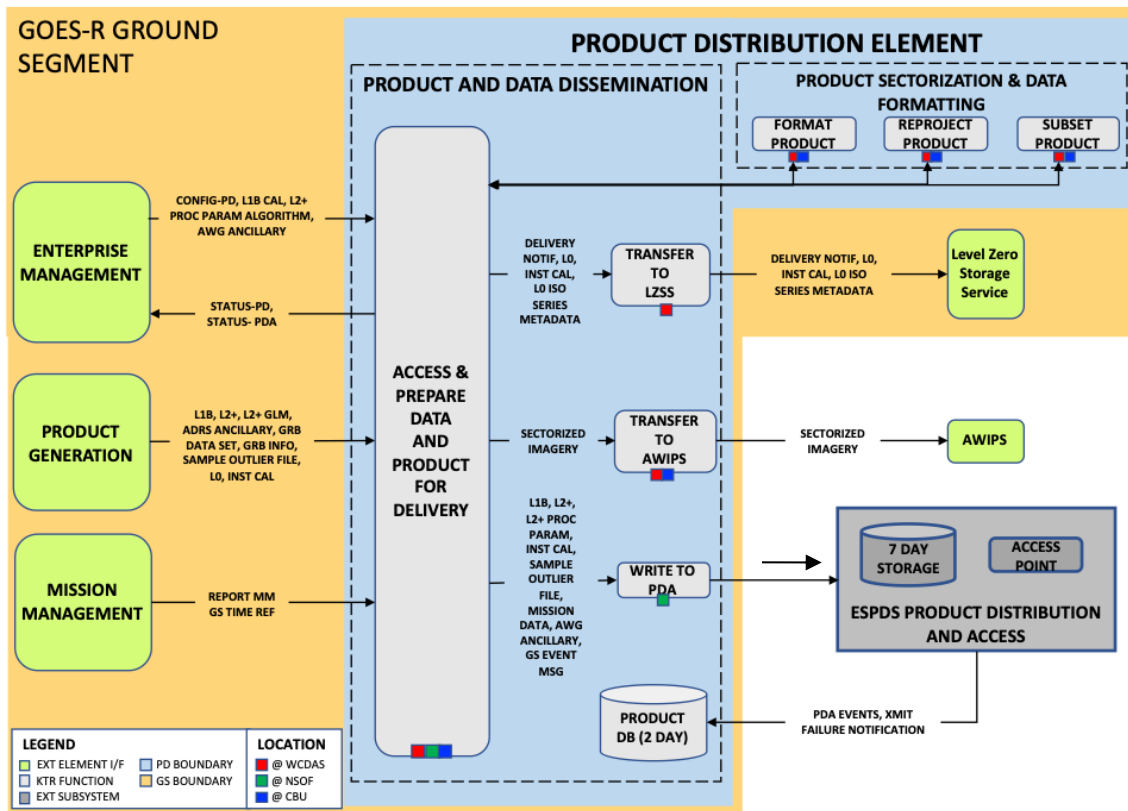

Figure 5: Product Distribution (PD) and Primary External Interfaces (CCR 1558, CCR 1803, CCR 2680A, CCR 2838, CCR 3584) CCOR PD not shown here

4.5 USER DESCRIPTION

The diversity of the GOES-R user community is reflected in the wide variety and applications of GOES-R data and products. Larger, institutional users can exploit the increases in spectral, temporal, and spatial resolution and assimilate radiances for use in prediction models, increasing the timeliness and accuracy of forecast products. GOES-R data are used by the National Weather Service in real-time for

critical life and property forecasting and warning applications. The users are able to monitor the rapid development and interaction of severe storms. Other smaller public and private sector users are able to obtain the GRB data through their own Earth stations, or through terrestrial network distribution. (CCR 1803, CCR 3584)

Some of the key National Weather Service user elements include the Weather Forecast Offices (WFO), the River Forecast Centers (RFC), and the units of the National Centers for Environmental Prediction (NCEP): Environmental Modeling Center (EMC), Hydrometeorological Prediction Center (HPC), Ocean Prediction Center (OPC), Tropical Prediction Center (TPC), Aviation Weather Center (AWC), Storm Prediction Center (SPC), Climate Prediction Center (CPC), Space Weather Prediction Center (SWPC), National Hurricane Center (NHC), and NCEP Central Operations (NCO). The WFOs and NCEPs receive GOES-R data principally via AWIPS. Other users within NOAA include the National Environmental Satellite Data and Information Service (NESDIS), the National Marine and Fisheries Service (NMFS), the National Ocean Service (NOS), and the Office of Atmospheric Research (OAR). (CCR 3019A, CCR 3584)

Department of Defense users include the 557th Weather Wing [formerly known as Air Force Weather Agency (AFWA)], the Fleet Numerical Meteorology and Oceanography Center (FNMOC), the Naval Oceanographic Office (NAVOCEANO), and the Naval Maritime Forecast Center/Joint Typhoon Warning Center (NMFC/JTWC). (CCR 3019A)

The academic community is also a large user of GOES-R data, for informational, education, and research purposes. Some specific academic institutions collaborate with NOAA/NESDIS sponsored research entities and are engaged in the development and creation of derived GOES-R satellite products.

4.5.1 User Classification

In addition to identifying individual user organizations, the user community may be classified according to their interaction with GOES-R mission data. The classes of users are defined as operational and retrospective users. All operational users, not established during procurement, will be authorized by OSPO, following GOES-R handover. Some organizations may contain multiple classes of users. (CCR 1803, CCR 3019A)

4.5.1.1 Operational Users

Operational users are organizations or entities inside or outside of NOAA who require timely, reliable access to GOES-R data or products to fulfill their mission, which in most cases is critical. Operational users may receive data with minimum latency by either of two mechanisms: direct broadcast via GRB relay service or network distribution.

GRB Users

These users will receive the full Level 1b data set via the GRB direct broadcast service. The GRB user class is the extension of the traditional GVAR community who receive real time GOES imagery via direct broadcast from the spacecraft, through procured Earth stations. However, GRB content will be greatly enhanced over GVAR, so users may use only part of the data (e.g. selected ABI channels only). (CCR 1803)

Network Distribution Users

Some operational users requiring regular or continuous access to selected products or data (up to and including the full L1b or, L2+ product set) will acquire these data via network distribution. Low latency

users (NWS field offices and centers) will acquire GOES-R data directly via the AWIPS network. Network distribution users accessing the PDA will have pre-established subscription agreements with OSPO and will have connectivity to a network of sufficient bandwidth to support the volume of product sets they request. (CCR 1803, CCR 2680A, CCR 3019A)

Operational users may request selected products for delivery through the PDA on a conditional basis through a subscription based on specified criteria. Operational users may also retrieve products up to 7 days old from the Product Distribution temporary storage via ad hoc (one-time) request. These types of requests are not regularly subscribed, but are interactive queries to receive a specific product or product set over a user-defined time span. Ad hoc requests may be made to: fill in a data gap arising from some problem in receiving real time data; instrument or spacecraft health and status telemetry for anomaly resolution; or requests may be made to obtain a product not normally subscribed to for analysis or other purpose. For retrospective data needs (greater than 7 days old), users will be redirected to CLASS to obtain these archival data independent of the GOES-R system. (CCR 1803, CCR 2680A, CCR 3019A)

4.5.1.2 Retrospective Users

Users requiring access to archived GOES-R data older than 7 days will access CLASS through the CLASS archive and access functionality. These users will typically be researchers investigating long-term phenomena or scientists, academicians, and developers needing historical data to analyze calibration parameters, etc. Retrospective users thus do not interact directly with the GOES-R system; they interface directly with the CLASS User Portal, which is outside the GOES-R System firewall. (CCR 1803)

Other users requiring occasional or infrequent access to GOES-R product data or information in non-critical applications will access these data from a source other than the GOES-R system. This user type includes the general public. A separate web-site (or similar functionality) to serve non-operational users may be maintained by another NESDIS organization.

4.6 DATA DISTRIBUTION OVERVIEW

GOES-R data and products are distributed by two primary categories, internal and external interfaces. There are two primary internal (internal to the GOES-R System) data transport mechanisms: space-based relay through the GRB rebroadcast service, and telecommunications networks. There are two types of external (external to the GOES-R System) interfaces, which are the ESPC PDA and the National Weather Service interface which allow external user access to the GOES-R System data. ESPDS PDA will also distribute GOES-R data to the CLASS system for external long-term storage, archival, and access. (CCR 1803, CCR 2680A, CCR 3019A, CCR 3584)

GOES-R Product Distribution support both large- and small-volume users. Supervision of all data distribution mechanisms are implemented within the GOES-R GS EM system. (CCR 1558, CCR 1803)

Figure 6 illustrates for the overview of the GOES-R data distribution system. (CCR 1803)

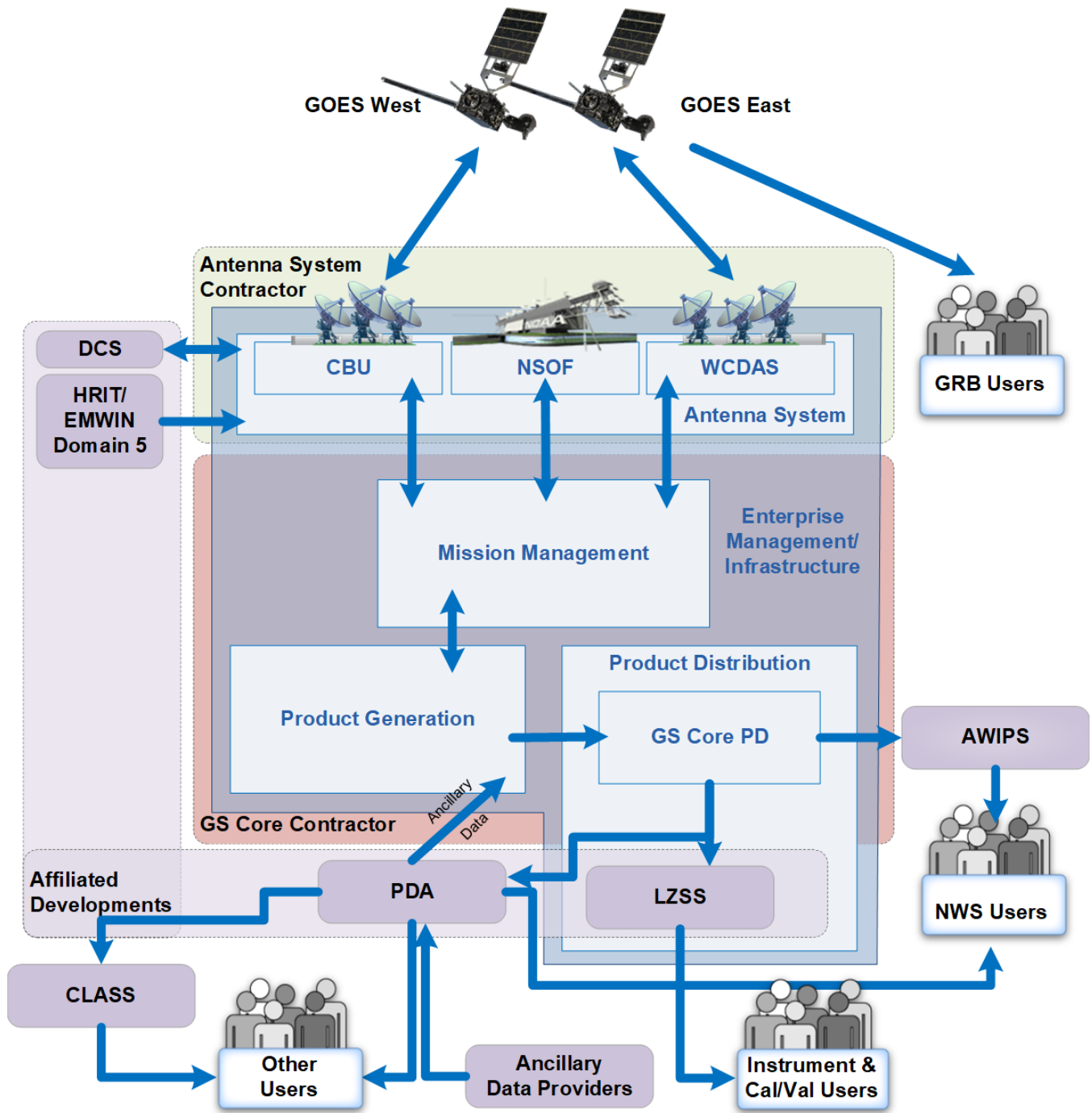

Figure 6: GOES-R Data Distribution System (CCR 1558, CCR 1803, CCR 2680A, CCR 2838, CCR 3584)

4.6.1 Internal Interfaces (CCR 1803)

4.6.1.1 Space Based Relay (CCR 1803)

4.6.1.1.1 GRB

The GRB service is the primary space relay of Level 1b products with a 31 Mbps downlink data rate. It is the extension of the legacy GOES-I/P series GVAR, and includes rebroadcast of Level 1b data from all GOES-R instruments. GRB is an internal and an external interface used both for internal Program L2+ product generation and by external users for generation of specific user products. For internal purposes, the data are transferred from the WCDAS/CBU sites to the NSOF for L2+ product generation via the WAN. The internally generated L2+ products are distributed to external users via the ESPDS PDA. (CCR 1803, CCR 3584)

GOES-R external users must either acquire new systems to receive GRB or upgrade components of their existing GVAR systems. At a minimum, existing GVAR systems will require new receive antenna hardware, signal demodulation hardware, and computer hardware/software system resources to ingest the extended magnitude of GOES-R GRB data. (CCR 1803)

The content of the data distributed via GRB service is the full set of Level 1b products from all Earth-weather instruments onboard the GOES-R series spacecraft plus calibration data ancillary and metadata. The GRB data rate is large enough to include all ABI channels in a lossless compressed format as well as data from the GLM instrument. (CCR 1803)

4.6.1.2 Broadband Relay (CCR 1803)

4.6.1.2.1 Network Distribution (AWIPS and PDA) (CCR 3019A)

Network distribution serves a large segment of GOES-R users. Network distribution operational users receive data through mechanisms consistent with meeting latency requirements as defined in pre-arranged agreements. Critical NWS elements receive KPP and imagery data directly via the GOES-R AWIPS interface within latency requirements. PDA users are also able to search and request data for one-time retrieval or to establish a subscription for delivery of data based on specified criteria. (CCR 1803, CCR 3019A, CCR 3584xxx)

PDA product distribution is controlled through the subscription manager process. Subscribed products are delivered directly from the PDA servers as they become available, in accordance with the required refresh rate of the particular product (including near real time for Level 1b imagery) and with the associated system latency.¹ Users may request their desired data by specific product. Subscription requests may include up to the full volume of Level 1b and higher level products. However, it is envisioned that few if any organizations will require access to all products from all GOES-R instruments via subscription. Managing PDA data distribution through a “customizable” subscription request is

¹ Ground Segment latency is measured from the GS acquisition of raw instrument measurements to posting to the GOES-R User Portal server. Latency associated with transfer of data from the server to the user over public telecommunications networks will not be included within the product latency requirement. Latency is illustrated in later sections of this document. (CCR 1803)

expected to make the process more efficient from a telecommunications standpoint. It is assumed that the subscription network distribution service will require the user to maintain a continuously open net link to the PDA. (CCR 1374, CCR 1803, CCR 3019A, CCR 3584)

4.7 EXTERNAL DATA DISTRIBUTION (CCR 1558)

4.7.1 Space Based Relay (CCR 1803)

4.7.1.1 Auxiliary Communications (CCR 1803)

The auxiliary communications services are not directly coupled to the GOES-R system with the exception of the GRB. The GRB was covered in the above section pertaining to Internal Services. The other auxiliary communications services are the DCS, the HRIT/EMWIN and the SARSAT. These communications services are “bent pipe” to the GOES-R satellite and are received, amplified and re-transmitted to external users and is performed independently of the GOES-R by dedicated transponders located on each of the GOES-R satellites. Operations of these services are also performed independent of the GOES-R system. The data distribution of the auxiliary communication services is as shown in Figure 7 and described below. (CCR 1803)

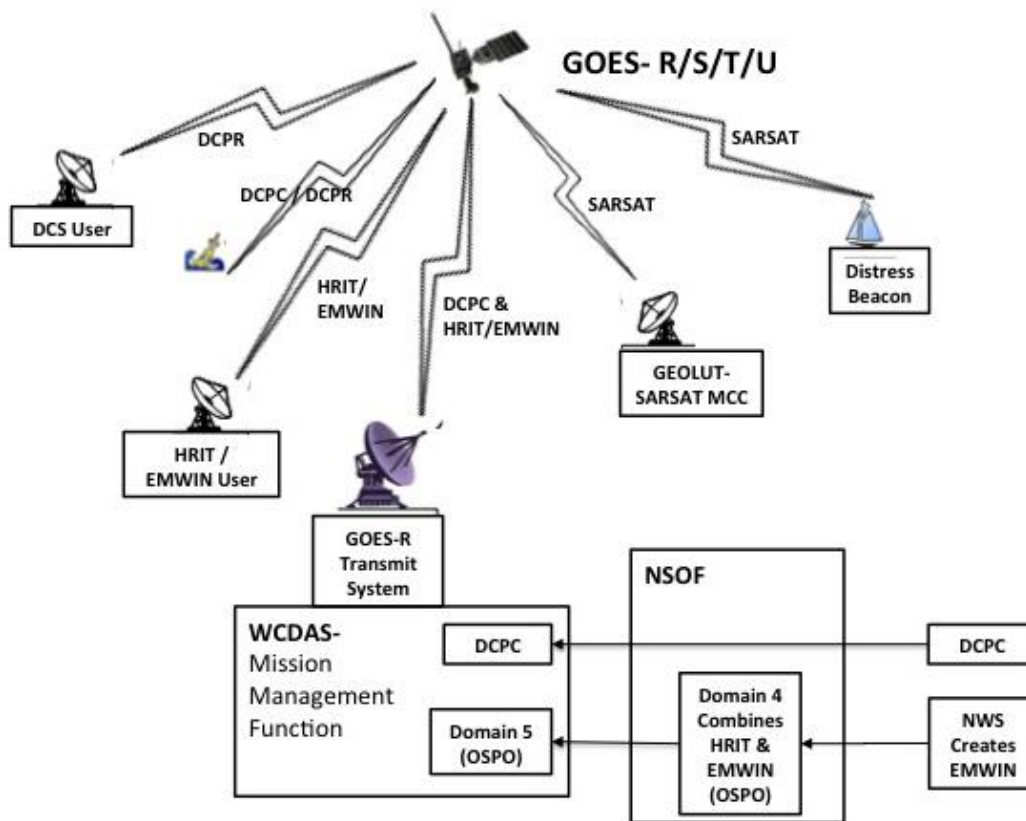

Figure 7: GOES-R Auxiliary Communications Data Distribution System (CCR 1803, CCR 2680A)

4.7.1.2 Data Collection System (DCS) (CCR 1803)

The GOES Data Collection System is a relay system used to collect information from a large number of Earth-based platforms that transmit in-situ environmental sensor data on predefined frequencies and schedules, in response to thresholds in sensed conditions, or in response to interrogation signals. The management of DCS ground system resources is outside the responsibility of GOES-R. (CCR 1803)

There are two types of DCS signals, DC Platform Commands (DCPC) and DC Platform Reports (DCPR). The DCPCs are generated outside the GOES-R system, routed to the WCDAS where the signal is modulated onto the GOES-R S-band transmitter and uplinked to the satellite. The DCS transponder transmits the commands to the DCS platforms. DCPRs are transmitted by the DCS platforms up to the transponder on the GOES-R, transmitted to and received at the WCDAS and routed back to the DCS for processing. (CCR 1803)

4.7.1.3 HRIT/EMWIN (CCR 1374, CCR 1803)

The Emergency Managers Weather Information Network (EMWIN) is a direct service that provides users with weather forecasts, warnings, graphics, and other information directly from the NWS in near real time. The NWS creates the EMWIN and routes it to the NSOF and the CBU. The Office of Satellite and Product Operations (OSPO) maintains the HRIT/EMWIN ground components at NSOF/CBU which creates the High Rate Information Transmission (HRIT) and includes the EMWIN data. The combined signal is routed to the Uplink Processor (XUP) at the WCDAS (and CBU when in COOP), which routes it to the GOES-R transmitter for uplink to the GOES-R. The GOES-R HRIT/EMWIN transponder receives the signal, amplifies and transmits the signal where it is received by HRIT/EMWIN independent user terminals. (CCR 1803, CCR 3019A)

4.7.1.4 SARSAT (CCR 1803)

The Search And Rescue Satellite Aided Tracking (SARSAT) transponder relays emergency beacon signals from marine, aircraft, or individuals in distress. The GOES-R satellite receives the uplink distress beacon, amplifies and transmits it down to and received by the ground support Geostationary Earth Orbit Local User Terminals (GEOLUTs) in the Cospas-SARSAT system. The GEOLUTs in turn dispatch and manage the rescue effort to that local area. The SARSAT service requires only signal monitoring by the GOES-R ground system. This is truly a “bent pipe” service to the Cospas-SARSAT system. (CCR 1803, CCR 3584)

4.7.2 Broadband Relay (CCR 1803)

4.7.2.1 Product Distribution and Access (PDA) (CCR 1374, CCR 3019A)

The Environmental Satellite Processing Center (ESPC) is a primary user of GOES-R data and reprocesses and distributes additional derived products to its user community. ESPC will receive GOES-R products from the PD segment (CCR 1803) for distribution by PDA to CLASS to archive. CLASS makes archived GOES-R data available to external users. (CCR 2680A, CCR 3019A, CCR 3584)

4.7.2.2 National Weather Service

The National Weather Service (NWS) is the primary operational user of GOES-R data. NWS elements receives selected L1b and L2+ data products directly from the GOES-R AWIPS distribution server and/or GRB. These elements include the National Centers for Environmental Predictions (NCEPs), and NWS Telecommunications Gateway (NWSTG). These NWS systems and organizations may provide

post-reception processing and distribution their respective users. The NWS also supplies ancillary data via OSPO to GOES-R for the generation of some L2+ products. (CCR 1803, CCR 2680A)

The NWS Space Weather Prediction Center (SWPC) is the primary operational user of the space environment and solar imaging instrument suites. Although processing and distribution of SUVI, EXIS, SEISS, and MAG L1b data are performed within the GOES-R PG and PD elements, SWPC evaluates the quality of space environment and solar products, and with tasking and scheduling of the payloads where applicable. The primary method of delivery of space weather data to the SWPC is via GRB. It is possible that selected SEISS and MAG data may be included in the spacecraft narrow-band telemetry link to facilitate continued space environmental data collection during the on-orbit storage mode. SWPC will produce the L2+ data products as required. (CCR 1803, CCR 3584)

4.7.2.3 CLASS

CLASS supplies permanent archive and retrospective access services for GOES-R data and supporting information as part of its mission as the single data repository for all NOAA environmental data. CLASS receives GOES-R data from ESPDS PDA (per GAS requirements) at ESPC. CLASS is the IT infrastructure supporting the National Climactic Data Center (NCDC) in Asheville, NC and the National Geophysical Data Center (NGDC) in Boulder, CO. CLASS operates from these two facilities. The facilities provide redundancy with similar hardware and identical software and are capable of assuming the overall CLASS load at any given time. During normal operations, both facilities are operational and share the processing and distribution load. (CCR 3584)

The content of the ABI, GLM, SEISS, SUVI, and EXIS data is routed by PD to PDA and then to CLASS for permanent archive, L2+ ABI and GLM data products are distributed by PDA to CLASS for permanent archive. CCOR data archive is outside of the scope of this document. Access to GOES-R data stored in CLASS for retrospective users is via the CLASS interface. GOES-U will send CCOR Level 0 data to SWPC, who will provide CCOR L0 data to NCEI. CCOR product generation, distribution and data archiving is outside the scope of this CONOPS. (CCR 1803, CCR 2680A, CCR 3019A, CCR 3584)

4.8 SUSTAINMENT

The GOES-R sustainment function encompasses program management, facility and property management, and business operations including procurement and replenishment. The approach will address technology insertion as the system matures, providing continuous product improvement while reducing overall support costs for the life of the GOES-R series. Databases are used to manage licenses and warranties and are closely coupled to the Enterprise Management function to automatically track and maintain the expatriation dates and renewals. (CCR 1803, CCR 3584)

4.8.1 Procurement

The Ground Segment Project will negotiate any necessary memoranda of agreement, licenses, and/or contracts needed to support GOES-R operations. The GOES-R system contains a substantial amount of both unique and COTS hardware and software. The sustainment function uses databases to manage licenses and warranties. Procurement activities will be automated to the maximum extent feasible. (CCR 1803)

4.8.2 Ground System Refresh

The GOES-R system refresh process will introduce upgrades prior to part or subsystem obsolescence. Nominal replenishment cycles will be optimized to the type of equipment. Certain elements like PC hardware may require more frequent replacement, while others such as product generation processors and Radio Frequency (RF) hardware may have more than a 5 year useful life. To the largest extent practical consistent with overall system security and availability requirements, replenishment activities will optimize Life Cycle Cost (LCC) across the GOES-R program. (CCR 1803, CCR 3584)

4.8.3 Facilities Support

The sustainment function ensures availability of NOAA's physical infrastructure to the GOES-R program. The facilities role is primarily a liaison to the NOAA site facility manager, assuring that the site facility operation's provides all necessary services. (CCR 1803)

4.8.4 Management Support

Management support will be performed in compliance with all applicable laws, rules and regulations. As part of this function, performance metrics, methods for calculating these metrics, action points for each metric (e.g. when a metric goes from "yellow" to "red."), and the actions associated with each metric will be identified.

4.9 FACILITIES

GOES-R system operations are performed from three facilities: The NOAA Satellite Operations Facility (NSOF) in Suitland, MD; the Wallops Command and Data Acquisition station (WCDAS) in Wallops Island, VA; and at the Consolidated BackUp site (CBU) in Fairmont, WV. Together, the NSOF and WCDAS comprise the "primary" sites for GOES-R operations and may be considered in certain respects as a single system, with WCDAS providing the Earth-Space communications functions and most higher level functions provided by NSOF. The CBU consolidates the functionality of the NSOF and WCDAS into a single "backup" site that can operate completely independently. The antenna suite spans all three facilities, will be operated independent of each facility, and comprise different antennae. The antenna suite infrastructure has been procured and installed at each location separately from other facility hardware. (CCR 1374, CCR 1803, CCR 3019A, CCR 3584)

Though not required for operations the system does also exist in two support locations. OSL1 is located at the GS Contractor facility in Melbourne, FL. This facility is used to assist with troubleshooting issues seen in operations as well as facilitating deployment of builds and changes to the system; changes must still go through the Operational CM procedures before factory can deploy. Note that there is no connection between the OSL and any factory equipment or networks. OSL2 is located at the NCWCP and is in place to support the Product Readiness and Operations (PRO) team with product and algorithm management. (CCR 3584)

4.9.1 NOAA Satellite Operations Facility (CCR 1803)

The NSOF is the primary operations site housing the GOES-R constellation mission operations, product generation, EM, and product distribution functions and houses the majority of operations and product staff. All GOES-R series mission operations, from pre-launch testing through sustaining operations, will be performed from NSOF. The NSOF houses the L2+ product generation and product distribution

interface to the GOES-R point(s) of presence for network distribution of products to the GOES-R Users Portal. NSOF also serves as the location for ESPDS PDA/ADRS to distribute GOES-R data to CLASS. (CCR 1803, CCR 3584)

4.9.2 WCDAS

The WCDAS is the primary site for Space/Ground RF communications. WCDAS houses the antenna suite required for dedicated links to each operational and stored spacecraft, the front-end equipment to acquire data and to uplink commands and data services, and the associated network interfaces to provide data to the GOES-R system. WCDAS processes data through Level 1b to produce GRB for uplink to the satellite and terrestrial transmission to the NSOF. In this way, WCDAS is able to maintain the GRB generation and rebroadcast service in case communications to NSOF are interrupted. WCDAS interfaces with and provides uplinks to the Unique Payloads Services and the HRIT/EMWIN services for broadcast. Staffing at WCDAS is sufficient for real time support of systems and maintenance, given that most functions are capable of remote operation from the NSOF. (CCR 1803, CCR 3584)

4.9.3 CONSOLIDATED BACKUP SITE (CCR 3019A)

Stringent availability requirements drive the GOES-R operational concept to include a remote site that duplicates the full functionality of WCDAS and NSOF through the production and distribution of critical life and property products. The CBU can perform product generation for all KPPs. The CBU has the following properties:

- The CBU will be a consolidated backup facility at a site that is visible to the operational and spare GOES satellites
- The CBU is sufficiently removed geographically from the WCDAS and NSOF to avoid events that would be catastrophic to either of those sites
- The CBU will be capable of simultaneously supporting both operational satellites, as well as health and safety support of any spare
- Availability requirements may drive the CBU to be operated concurrently with the NSOF and WCDAS so that no data through Level 1b is lost should either primary site (NSOF and/or WCDAS) suffer an operational failure.

(CCR 3019A, CCR 3584)

Remote operation of most if not all CBU functions will be performed from the NSOF, with capability of remote operation from WCDAS. CBU staffing consists mainly of maintenance personnel. While remote operation of the CBU is designed into the system, it is capable of fully independent operation should one or both of the primary sites be disabled. Other benefits of a full-function CBU include flexibility for systems integration & testing and fail-over resources for periodic maintenance of equipment. (CCR 3019A, CCR 3584)

Operation of the CBU is key to both system availability and Continuity of Operations (COOP) requirements. Full automation of all operational elements together with limited on-site staff support may make it feasible to operate the MM, PG, and PD strings of CBU concurrently (i.e. full-up “hot” mode), giving very short response time to system or component failures. The EM element design makes remote, concurrent operation of the CBU and of automated fail-over inherently part of the system. (CCR 3019A)

4.9.4 Antenna Infrastructure (CCR 1803)

The GOES-R Antenna System is part of the comprehensive GOES-R GS and is a subsystem of the Mission Management Element. The terminology of “Antenna System” includes all components across all three sites required to receive or transmit RF signals to/from the satellites through the Intermediate Frequency Distribution System (IFDS) interface demarcation point with the GS. (CCR 1803)

Within the GOES-R Antenna System, the term “antenna station” designates a single reflector/pedestal assembly together with all associated transmit and receive equipment (normally located within or in close proximity to the antenna pedestal) required to establish an uplink/downlink communication path with a single satellite. It also includes all local monitor and control equipment required for a single antenna station. There are three new GOES-R system antenna stations located at WCDAS and at the CBU. (CCR 1803, CCR 3019A, CCR 3584)

Preliminary plans are to operate the GOES-R ground system similarly to the previous GOES-I/M and GOES-N/P mission support concept. (CCR 1803, CCR 3584)

The new GOES-R system antenna stations located at WCDAS is designed for full operation in sustained winds corresponding to a Category 2 hurricane (up to 110 mph) to enhance their robustness and give NOAA wider options to plan contingency scenarios. The “hurricane” rating at WCDAS is also necessary because the new GOES-R system antennas must also be capable of supporting GOES-N/P, which is required to operate from WCDAS under high wind conditions. (CCR 1803, CCR 3584)

During normal operations, the GOES-R system antennas and associated equipment at both WCDAS and CBU are monitored and controlled from the WCDAS operations room, with backup monitoring by operators at NSOF via remote GOES-R system Antenna Monitor, Control, and Test subsystem (GAMCATS) workstations. The capability exists to assume primary monitor and control from NSOF for contingencies (e.g. during a transition to CBU operations if WCDAS becomes unavailable). (CCR 1803, CCR 3019A, CCR 3584)

The CBU is primarily used in a continuity of operations mode, and is capable of rapid fail-over (“hot-swap”). The CBU is not normally used to actively swap primary command and control and/or GRB processing functions in an autonomous or semi-autonomous mode during conditions such as rain-fade events, but the CBU is designed to support this concept. The CBU may be used to cover scheduled or predicted periods of interference with normal operations, such as seasonal solar RF interference periods and preventative maintenance activities. (CCR 1803, CCR 3019A, CCR 3584)

5 GOES-R SYSTEM OPERATIONS

Space and ground system operations principles and some specific descriptions of operational flow are given in the following sections.

5.1 OPERATIONAL PHILOSOPHY

The GOES-R system operations concept is based on the following three principles expressed in order of importance:

- Launch and operate the constellation safely.
- Acquire and disseminate spacecraft telemetry, instrument, and product data to meet requirements.
- Operate as efficiently as possible. Efficiency is measured by the cost of achieving the first two objectives while meeting product data availability and latency requirements.

These principles comprise the foundation of the operational system. Each facet of GOES- R mission operations will address these priorities.

5.2 AUTOMATION

The key success criterion of automation in the GOES-R system is satisfaction of the fundamental operational principles. Well designed and robust automation reduces the probability of operational error through human or procedural faults, especially in dealing with highly complex systems. A concomitant benefit of automation may be the reduction of the large life cycle cost component represented by sustaining operations staffing.

Almost all GS elements contain candidates for automation, including ground station operation, MM, product generation, product distribution, and network control. Instrument data processing is inherently automated and even the previous GOES-I/P product processing system implements a high level of automation. Some areas of automation are implemented for discrete elements and some will cross functional boundaries. (CCR 1803, CCR 3584)

The spacecraft and instruments utilize onboard failure detection and correction for critical systems such that ground intervention is not necessary for credible single-point faults or failure modes requiring immediate response. This discussion applies mainly to areas of automation in ground support and product control. (CCR 3584)

It is recognized that implementing automation requires a higher initial investment in resources for development and testing of new systems, but the benefits are realized during the prolonged period of normal mission operations where safe management of the space assets and delivery of mission data are paramount. Automation is being introduced to various parts of the system in phases, so that confidence may be built through extended periods of parallel operation. A phased approach also permits the implementation of further automation as technology evolves over the mission lifetime. Although certain mission-critical functions may be the best candidates for full automation, it is necessary that manual overrides permit operator and engineer control of all critical systems. An example would be automatically issuing certain critical commands or commands in response to sensed spacecraft or instrument conditions. (CCR 3584)

5.3 TRANSITION FROM GOES-N/P

Transition to operations using the GOES-R satellite marked a significant change for the GOES program. Changes include:

- Operation of a completely new GS
- New backup site
- New S/C bus
- New and complex instruments
- New product set
- New product distribution methods
- New data formats for processed data rebroadcast

(CCR 1803, CCR 3584)

A primary objective of the transition was the continuity of geostationary data products to the NWS and broader user community. For each implementation of the GOES-R system, the collection, processing, and distribution of GOES-N/P products remained largely unaffected. GOES-R operates as an independent system to GOES-N/P. Extensive planning and testing ensured non-interference on operational GOES missions. Any modifications to existing infrastructure for GOES-R support, including antennae, networks, or facilities, did not affect continued operation of the legacy system.

Transition of the DCS and SARSAT Unique Payload Services was straightforward. HRIT and EMWIN users were presented with a higher data rate signal on a new transmit frequency. However, the ability to use the existing small aperture antennas was retained. HRIT and EMWIN changes have been designed to permit low-cost software-defined radio solutions for user systems that were deployed in advance of the GOES-R operational date. (CCR 1374, CCR 3584)

5.3.1 Transition timeline

The GOES-R satellite was launched and tested through the completion of the post-launch test phase while GOES-O and -P were still operational as GOES-East and GOES-West. GOES-R/16 replaced GOES-13 as GOES-East. GOES-S/17 was launched and replaced GOES-15 as GOES-West after check out. GOES-S/17 becoming GOES-West represented full operational status of the GOES-R series constellation. However, a GOES-S/17 on orbit instrument anomaly resulted in the revised Geostationary timeline shown in Figure 8. (CCR 1558, CCR 3584)



NOAA Geostationary Satellite Programs Continuity of Weather Observations

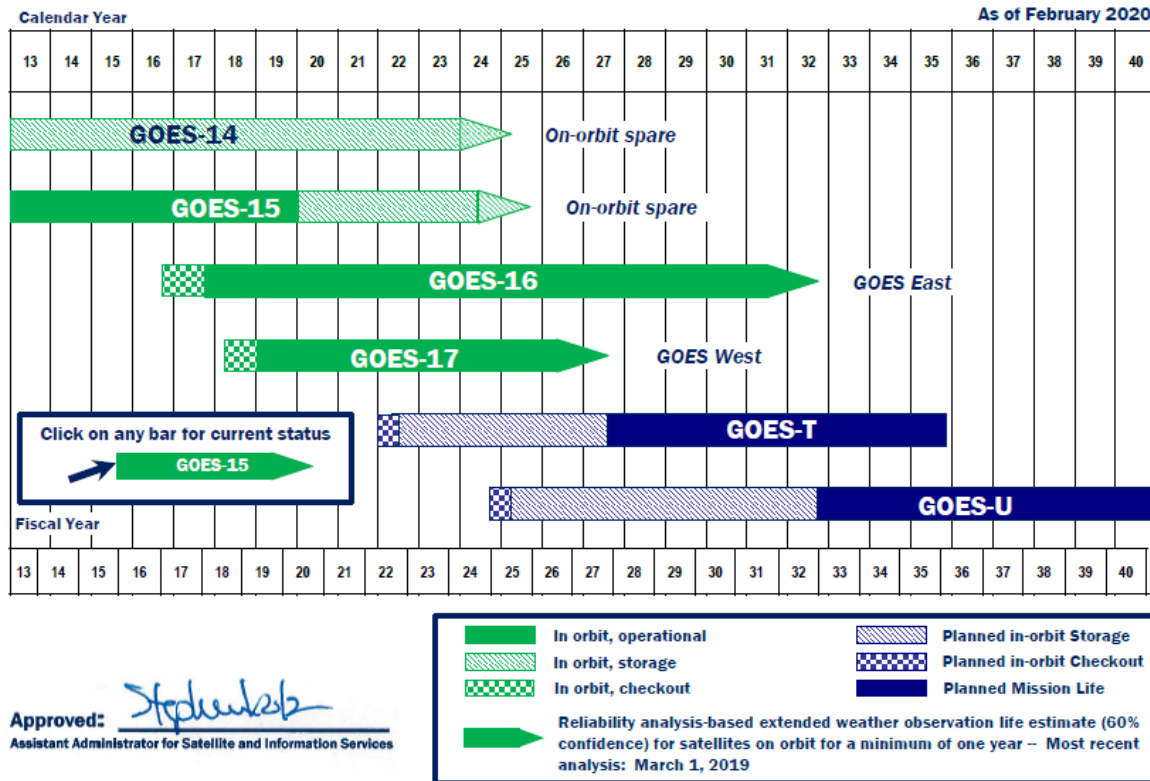

Figure 8: Geostationary Satellite Observation Timeline (CCR 1558, CCR 2680A, CCR 3019A, CCR 3584)

5.4 MISSION OPERATIONS SUPPORT TEAM

The Government has formed a dedicated team focused on every aspect of mission operations, from pre-launch planning and development, through launch and orbit raising, post-launch test, and transition to sustaining operations. The Mission Operations Support Team (MOST) is comprised of personnel from both the GS and Flight Projects, including discipline engineers (spacecraft bus and instrument), systems engineers, flight and ground controllers, mission planners and schedulers, ground systems engineers, software maintenance, and associated support personnel. Membership includes spacecraft, instrument and ground system contractor personnel, depending on mission phase, and representation from Program Systems Engineering. A key feature of the GOES-R MOST is membership of several NOAA operations staff dedicated to GOES-R mission operations in the early stages of pre-launch development. The MOST is led by the GOES-R Mission Operations Manager (MOM). (CCR 1374, CCR 1803, CCR 3019A, CCR 3584)

The MOST works closely with spacecraft, instrument, and ground system contractor personnel to acquire all the information and training materials required to fulfill mission operations goals. Responsibilities of the MOST includes:

- Responsibility for all command and control of the satellite from launch until hand-over to NOAA at the conclusion of the PLT period.
- Development of routine, contingency and special operations command procedures
- Development command schedules and sequence-of-event scripts for Launch and Orbit Raising (LOR) and normal flight operations
- All on-console operations from pre-launch testing, launch and orbit-raising, and post-launch test support.
- Off-line engineering analysis of flight and ground system performance during pre-launch, LOR, and PLT periods
- Database validation through ground and space segment operations testing (CCR 1558)
- ETE test planning, preparation, execution, analysis, and reporting
- Post-Launch Test planning, preparation, execution, analysis, and reporting
- Mission readiness testing
- Coordination of external elements for LOR
- Participation in GS site acceptance and regression testing
- Participation in Flight systems reviews
- Preparation for hand-over to NOAA routine operations including training and certification materials
- Satellite Simulator “ownership” including configuration control and resource scheduling
- Definition of routine, contingency, and special operations simulations and crew rehearsals
- Engineering configuration management
- Mission planning and scheduling
- Participation in mission operations software tool development

MOST participation commences early in the space and GS integration periods (approximately L-4 years) with a core engineering staff performing pre-launch development activities. Additional staff, such as controllers and mission planners, are added as launch preparation activities accelerate, with a fully staffed MOST in place by L-18 months. (CCR 1558, CCR 1803, CCR 3584)

5.5 Ground Readiness Team (GRT) and Product Readiness and Operations (PRO) Team

The Government has formed a dedicated team focused on product data operations similar to the MOST team. The GRT is comprised of personnel from the GS Project, Program Systems Engineering (PSE), OSPO, and GS Contractor. Working closely with the GRT is the PRO, including personnel from STAR, PSE, OSPO, NASA as well as instrument and product science experts. Membership for both teams includes experts on GOES-R user interfaces, user application of GOES-R product data, product generation systems, ancillary data interfaces, and other related disciplines. During the pre-launch phase, the primary focus of the GRT is to perform the set of activities that serve to validate ground system readiness for launch and Post-Launch Test. During the post-launch phase, the primary focus of the GRT is to validate the entire PG process via execution of the product-related Post Launch Tests and analysis of PG performance, ensuring that GOES-R product operations are ready for hand-over. Functions of the GRT include: (CCR 1803, CCR 3584)

- Develop product operations procedures
- Plan and conduct pre-launch tests with external user interfaces
- Participate in PG and PD system acceptance and regression testing
- Off-line engineering analysis of product generation and distribution performance
- Prepare for handover to OSPO for routine product operations

GRT activities commenced early in the GS integration period to allow experience gained from the initial stages of GS development to be propagated through GOES-R product generation and distribution operations. (CCR 1374, CCR 1803)

During the pre-launch phase, the PRO is responsible for developing in-depth product validation approaches and user readiness plans. It coordinates closely with the GRT to assist verification of PG systems, test and validate PD functions and external interfaces. During the post-launch phase, PRO coordinates the execution of the Calibration/Validation plan, and the Readiness and Implementation Plan (RIMP) to evaluate and operationalize each product with internal and external stakeholders.

Functions of the PRO include:

- Develop Readiness and Implementation Plans for each product
- Participate in the validation of product performance attributes during Post-Launch Test (PLT) and Post Launch Product Testing (PLPT)
- Coordinate updates to L2+ product algorithms with the Algorithm Working Group (AWG)
- Coordinate the transition of each product from each defined level of maturity to full operations with OSPO.

5.6 PHASES AND MODES OF OPERATION

5.6.1 PHASES

5.6.1.1 Pre-Launch

The pre-launch mission phase consists of all activities from the start of Acquisition and Operations until commencement of the launch sequence flow. The pre-launch phase includes all spacecraft and instrument design efforts, reviews, ground system development and testing, spacecraft and instrument integration and test, pre-launch calibration, verification and validation, space-to-ground End-to-End test, mission analysis, operations procedure development, and launch vehicle integration.

The GOES-R Ground Segment Project role during the pre-launch phase includes participation in all milestone reviews; oversight of component, system, integration, and segment-level testing oversight. Participation by the MOST includes development of spacecraft and instrument command procedures, ground system site acceptance testing, flight-to-ground End-to-End test planning and execution, mission readiness testing, and training, simulations and rehearsals in preparation for launch. (CCR 3584)

5.6.1.2 Launch and Orbit-Raising

Launch and Orbit-Raising (LOR) consists of actual launch vehicle operations beginning with the launch countdown flow, launch and powered flight, transfer orbit injection (if not direct injection), and associated orbit-raising maneuvers performed by the spacecraft to achieve the final geostationary mission orbit at the designated station. The LOR phase involves many unique modes and configurations of the satellite system and relies heavily on involvement by the manufacturer to ensure safe and efficient execution of the orbit-raising events. Many unique configurations of the ground system also occur during LOR. Supplementary ground station network support, tracking data acquisition and processing for orbit determination, and orbit-raising maneuver planning will be used for LOR.

Launch and Orbit-Raising is performed by the MOST, supplemented with flight system contractor personnel, ground system contractor personnel, and NOAA operations personnel. (CCR 3584)

5.6.1.3 Post-Launch Test

The Post-Launch Test (PLT) phase begins immediately after LOR and acquisition of the desired checkout orbital location with the execution of a pre-defined series of spacecraft and instrument test plans. These test sequences are designed to verify compliance with all space and ground segment mission requirements. The PLT phase consists of two distinct periods; Activation and Characterization Test (ACT) and System Performance and Operations Test (SPOT).

The ACT period consists mainly of functional verification of spacecraft and instrument operation, and includes some perfunctory tests. Typically, the ACT phase is of several weeks duration, although some orbit- or seasonally-dependent tests may not be completed until later in PLT. ACT tests will verify all spacecraft modes and components required for normal and special operations, as well as selected contingency modes.

The SPOT period consists of detailed verification and validation (V&V) of each aspect of flight and ground system performance, through V&V of the end user products. SPOT tests include special commanding to generate and capture any diagnostic data required for detailed analysis of system performance. The emphasis is on validation of instrument radiometric performance and Image Navigation and Registration. Most post-launch instrument calibration and validation activities are performed during SPOT in accordance with the GOES-R Program calibration and validation strategy. The SPOT phase is of a more extended duration than ACT, typically lasting for months or until all requirements are verified and the mission is declared operationally ready.

All post-launch testing is led by the MOST, with heavy involvement of spacecraft, instrument, and ground system contractors. Note that although most PLTs are defined as spacecraft and instrument flight segment test sequences, V&V of all ground system and operational elements is implicit in each test. The PLT period is also when operational procedures are refined and flight experience is acquired to facilitate safe and efficient mission operations.

5.6.1.4 Operational

The transition from the MOST to NOAA for satellite operations at the completion of SPOT is termed 'handover'. At handover, the satellite is declared operational and may be put immediately into service at the East or West station, or it may be placed into on-orbit storage mode for later call-up to operational service. Handover of the satellite will occur for each successful launch. Handover of the ground system from the MOST to NOAA occurs following the first successful GOES-R launch, but after satellite handover, when all significant discrepancies are resolved. The NOAA Office of Satellite Operations is responsible for all mission operations and data acquisition for product generation and distribution during normal operations. The GOES-R Program continues to support anomaly resolution, special operations planning, and other non-routine functions.

The Initial Operational Capability (IOC) and Full Operational Capability (FOC) phases are defined for the constellation system, rather than as a phase of an individual satellite. The constellation IOC phase was reached when the first GOES-R series mission satisfactorily completed the SPOT phase of PLT, and the complete flight and ground system has been verified as meeting all functional, performance, and availability requirements for KPPs. At IOC, the first GOES-R series satellite was declared ready for operations. (CCR 3584)

The constellation FOC phase is reached when KPP requirements of both East and West operational stations are met exclusively with GOES-R series resources. FOC thus occurs with satisfactory completion of the follow-on mission SPOT that provides full imaging and ancillary instrument payload capability at both stations.

5.6.1.5 Deactivation

The deactivation phase occurs when a satellite is declared to be incapable of providing useful mission data or other services and requires disposal to meet international guidelines for the stewardship of geosynchronous resources. This phase includes all mission planning and execution to boost the satellite to a supersynchronous orbit with a perigee no less than 300 km above geosynchronous altitude. (This operation is also referred to as “de-orbit”.) Following orbit boost, propellant is depleted to the greatest extent possible and all systems are deactivated so that no spurious RF is radiated and the probability of vehicle break-up is minimized. All deactivation activities are accomplished by NOAA Operations, with planning support from the GOES-R Program.

5.6.2 MODES

5.6.2.1 Pre-Operational

The pre-operational mode describes a state of the space and ground systems where mission orbit has been achieved, but routine mission operations have not begun. In this mode, it is possible to configure the satellite or ground system in ways not possible or permissible once the mission has been declared operational. PLT is performed in pre-operational mode. The pre-operational mode of a mission will only occur after launch and orbit raising, prior to operations or on-orbit storage.

5.6.2.2 On-Orbit Storage

On-orbit storage is defined as a functional satellite (either fully meeting performance and availability requirements or in a degraded mode with partial functionality) that is not being used to provide any operational service. Usually, the spacecraft will be commanded to an attitude control mode specifically designed for on-orbit storage that minimizes the need for operator interaction and provides safe conditions for the spacecraft and instruments, especially with respect to power and thermal constraints. A “stored” satellite is typically stationed at or near 105 W longitude where geopotential terms reduce the need for East/West stationkeeping management. GOES-R series satellites are capable of up to 5 years of on-orbit storage in addition to meeting operational lifetime goals. Support requirements for a stored satellite will be much reduced over an operational satellite, including relaxation of East/West stationkeeping requirements. However, full health and safety activities will be maintained, including continuous real time monitoring. It is possible that SEISS and MAG data will be acquired from a stored satellite consistent with attitude-dependent antenna geometry capabilities.

5.6.2.3 Normal mission operations

The normal mission operations mode is defined as a satellite providing the nominal set of mission product data and services in a routine fashion from one of the two operational stations. Normal mission operations could also occur from a central CONUS location, if directed, to supplement the East or West missions or from another location to extend geographical coverage beyond the nominal coverage zones.

5.6.2.4 Degraded capability

The mode of a satellite may be declared ‘degraded’ when one or more instruments or services do not meet mission requirements, either due to the degradation or failure of a component or subsystem, or to the exhaustion of resources (e.g. propellant). An example of a satellite in degraded mode would be failure of the primary instrument, but with secondary instrument and communications payloads still providing useful functions. In this mode, the on-orbit resource may still be useful for the partial fulfillment of a mission even though full availability requirements are no longer met. A degraded satellite may also be useful for an alternative or supplementary purpose in post-mission operation mode.

5.6.2.5 Post-mission operation

It is possible that once a mission is taken out of on-station operation as GOES-East or GOES-West, it may be utilized to provide data or communication services for a supplementary mission. These missions will be defined by NOAA management on a discretionary basis, either to supplement US meteorological capability or for international services.

5.7 ORBIT DETERMINATION AND CONTROL

There are two operational stations specified for GOES-R: GOES-East at 75.2 W longitude, and GOES-West at 137.2 W longitude. (The shift of the West station from 135 W for previous GOES missions to 137 W for GOES-R was necessary to avoid X-band interference issues.) The GOES program also uses two additional locations: 105 W for maintenance of the on-orbit spare satellite, and 89.5 W for post-launch testing. Orbit control requirements are +/- 0.1 deg North/South (inclination) and +/-0.1 deg East/West. The 0.2 deg “orbit box” constraint is important to de-conflict X-band RF resource issues, but requires more frequent orbit maintenance maneuvers. East/West orbit control requirements will be relaxed for a satellite in on-orbit storage to reduce the frequency of maneuvers. (CCR 3019A, CCR 3584)

Orbit maneuver planning and scheduling is an internal function of Mission Management. While orbit adjust maneuvers have traditionally been considered special operations with associated risk requiring full engineering team involvement, the possibly greater frequency and smaller magnitude delta-v of GOES-R series East/West maneuvers, coupled with greater spacecraft autonomy, drive these operations to be executed in a more routine mode if the propulsion system presents low risk and little disturbance to normal product flow. (CCR 3584)

Onboard orbit determination presents a major advancement in autonomy over heritage GOES missions. Moving the orbit determination process onboard decouples precision orbit determination from the INR process and reduces the complexity of daily operations. The capability for alternate methods of orbit determination, such as metric ranging through NOAA or other network ground stations, are maintained for contingencies and as verification of onboard orbit solutions, albeit at a lower accuracy than onboard solutions. A separate S-band coherent telemetry and command link is specified such that DSN-type tone ranging may be conducted without interference to either the nominal command or telemetry path. The capability for digital ranging using the GRB carrier (analogous to the previous GOES-I/P GVAR ranging scheme) may also be used.

5.8 FREQUENCY UTILIZATION

GOES-R uses much of the previous GOES program frequency band allocation, but in addition will use X-band frequencies to accommodate the high data rate transmissions required by the advanced

instrument payloads. S-band command uplink is close to the previous command frequency. Normal space-to-Earth meteorological L-band frequencies are used for GRB and engineering telemetry downlinks. The Unique Payload Services communications frequencies are also maintained at or close to the previous allocation, with the exception that the EMWIN and HRIT data are combined into a single service and transmitted on a single carrier. Note that the “DSN” acronym refers to the S-band coherent downlink at the 240/221 ratio of the uplink rather than implying use of actual NASA Deep Space Network resources, which may not exist in their present form during the GOES-R era. In addition to being the primary ranging method during launch and orbit-raising, the S-band Orbit Raising, Tracking, Telemetry and Command (ORTT&C) link is utilized during nominal on-orbit operations as a backup to the L-band CDA engineering telemetry downlink. The independent ORTT&C link is also used to maintain independent telemetry and command when two spacecraft are collocated or in a cross-over close approach during station drift. Additional telemetry downlink flexibility is available through the X-band raw data downlink, which has the capability to include spacecraft or instrument engineering data. The X-band supplementary telemetry may be utilized for dwell on selected engineering data items. Normal operational practice is to have two independent engineering telemetry links active at all times. (CCR 1374, CCR 3019A, CCR 3584)

National Telecommunication and Information Administration (NTIA) filings have been made to radiate all GOES-R frequencies listed above from four orbital locations: 75W, 89.5W, 105W, and 137W. The 89.5W location permits full PLT function from the central “check-out” station, as well as provide for possible full operations from a central CONUS station should that option ever be exercised by NOAA. The 105W location is necessary for maintenance of the on-orbit storage spacecraft and allows for periodic tests of full-up instrument operation at the storage location. Stringent NTIA regulations controlling the radiation of X-Band frequencies may preclude the transmission of raw data from any but the four designated longitude stations, constraining imaging operations during station relocation drifts. (CCR 3019A, CCR 3584)

5.9 MISSION OPERATIONS

The GOES-R system is a critical national resource that requires the highest level of mission operations support, utilizing mission operations best-practices, rigorous engineering configuration management, and extensive development and testing of normal and contingency operations procedures.

Console operations are continuously staffed at the NSOF. Operators ensure proper execution of all satellite commanding, monitor the performance of the satellite and ground segment, and respond to any real time request or anomaly. Operators also remotely monitor the status of WCDAS elements and CBU functions, and configure those resources as required. (CCR 3019A, CCR 3584)

Spacecraft engineering ensures spacecraft health and safety and maintains a continuous flow of high quality mission data. This support includes performance analysis and long-term trending of all spacecraft subsystems, INR analysis and operations, anomaly investigation and resolution, maneuver planning and execution, and engineering procedure and database development and maintenance. Satellite and operations procedure development may utilize COTS systems for development and configuration management. (CCR 3584)

Instrument engineering monitors instrument performance and detects, diagnoses and resolves instrument anomalies. Instrument performance analysis evaluates significant instrument performance parameters, analyzing short and long term trends, archiving all pertinent data for future use, and performing

statistical analysis of data pertaining to instrument radiometric calibration and performance. Activities include assistance in resolving product data anomalies, quantitative monitoring of product data at Level 0 and Level 1, and providing information to support data calibration activities to maintain the highest quality products on a continuous basis. GOES-U CCOR Level 0 data only will be sent to SWPC, who will forward CCOR L0 data to NCEI while higher-level products are beyond the scope of this CONOPS. (CCR 3584)

The following are key features of NOAA's mission operations methodology that apply to GOES-R:

5.9.1 Commanding

- Validation of all database commands sent to the satellite.
- All special (non-routine) command sequences are validated via the high-fidelity spacecraft simulator.
- Initial validation of command sequences for tasks used on a regular basis.
- Definition of a critical command set requiring special directives prior to transmission.
- Prerequisite checking and telemetry end-item verification of all discrete commands.
- Commands embedded in command procedures for all routine and special tasks, developed using engineering judgment according to specified sequences and conditions. Command procedures include descriptive messages to operators for executing the procedure and for interpreting errors due to non-nominal execution.
- Command schedules comprising pre-defined time-sequenced command procedures or command loads for automatic execution.
- Routine commanding accomplished from stored loads using Relative Time Sequence (RTS) loads for discrete activities (e.g. for sets of commands comprising a repetitive function such as a calibration or maneuver activity), or using Absolute Time Sequence (ATS) loads for controlling routine schedule execution.
- Schedule validation and constraint checking automated wherever possible.
- Encrypted commanding and authentication in all cases except in certain contingency scenarios.

5.9.2 Telemetry Monitoring and Trending

- Efficient textual and graphical display of critical telemetry parameters and event messaging.
- Ground system status and performance display for real time monitoring.
- Pre-defined and ad hoc user-defined pseudo-telemetry algorithms.
- Robust telemetry limit capability that includes adaptive limit algorithms to follow predicted functions and register deviation from the normal expected trend, rather than relying only on a constant high/low limit value. Some adaptable limit functions may be simple mathematical fits over data with statistical periodicity, or some may be triggered by automatic event detection or context-dependency (e.g. turn-on of a component, mode change, or predicted orbit event such as eclipse).
- Engineering Analysis system that permits fast and easy access to near-real time and historical archive data.
- Remote Access system that streams real time data and permits archive data retrieval via web interface, and that may also include real time streaming of critical engineering telemetry data to handheld devices.

5.9.3 Routine Operations

Routine operations are performed continuously by on-console personnel. The main operations tasks are performed from the NSOF. Responsibilities of the NSOF operators include the following (where some processes are automated, operators oversee proper execution of the automated process):

- Monitor satellite telemetry for proper execution of commands (onboard command sequence or real time)
- Monitor satellite telemetry for limit violations or changes in telemetry that may be a precursor to limit violations
- Monitor satellite telemetry for anomalies that threaten satellite health and safety, and to take appropriate action to ensure health and safety in the event of a flight system anomaly
- Monitor the Level 1b GRB product using the Product Monitor
- Monitor the end-to-end configuration and performance of the Ground System via the real time component of the EM functionality
- Ensure operational continuity in the event of a ground system anomaly
- Respond to anomalies in product data detected in the Product Generation function
- Respond to problems or requests received through the Help Desk function of User Services
- Implement scheduling change requests through the instrument tasking process
- Contact engineering, ground system, or supervisory personnel in the event of a significant anomaly

5.9.4 Housekeeping Operations

Housekeeping operations are activities occurring on a regular basis for maintenance of satellite functions. Examples of routine housekeeping activities would be momentum management, clock maintenance, memory dumps or other onboard processor management, or subsystem reconfigurations not covered by onboard autonomy. Any periodic instrument calibration, such as SUVI/EXIS platform off-pointing or MAG calibration sequence commanding, would be scheduled as a housekeeping activity. It is possible that East/West stationkeeping management requirements may be met using frequent incremental delta-v maneuvers. This type of maneuver scheme would evolve into a routine housekeeping function once validated. Any housekeeping activity not controlled autonomously onboard would be planned by the scheduling function.

Daily “outage” periods to accomplish housekeeping functions are not specified for GOES-R. Stringent total yearly outage requirements drive all routine housekeeping activities to be accomplished without interruption in instrument data collection or relaxation of performance specifications.

5.9.5 Special Operations

Special operations are activities not occurring during the course of daily routine operations and that are associated with a higher level of risk than routine operations. Typically, special operations activities are supported by offline engineering staff and managed using prescribed operational procedures. Activities with a high degree of complexity and risk, such as non-routine attitude or orbit maneuvers, also require significant preparation. This preparation includes all associated planning and scheduling, detailed SOE review, contingency planning, and SOE validation and crew rehearsals via high-fidelity spacecraft simulation. Special operations may include North/South stationkeeping maneuvers, yaw flip attitude

maneuvers, spacecraft subsystem or instrument configuration changes, storage mode or normal on-orbit mode acquisition, or special instrument calibrations or diagnostics.

5.9.6 Anomaly Operations

Satellite anomaly operations will occur when the spacecraft bus or instruments experience a failure or degradation in function or performance that affects normal data collection, or otherwise compromises the health and safety of the satellite system. Anomalies could be sudden, discrete events, such as the failure of a critical component, or could be a gradual degradation in performance detected by engineering trending that permits action prior to the occurrence of a mission-threatening situation. Onboard failure detection and correction respond autonomously to spacecraft and instrument anomalies in many cases, but it is the responsibility of real time operators to respond to any contingency situation in accordance with pre-defined procedures. Mission operations engineering will receive notification of any actual or suspected satellite anomaly through either operator contact or automated ground system functionality. Engineering support will respond in near real time when required. The remote access system will enhance anomaly response by allowing engineers who may be off-site to acquire and analyze satellite telemetry expediently. All anomaly investigations and corrective actions will be thoroughly documented in reports and managed under document configuration control to ensure that the knowledge base is maintained throughout the program lifetime. (CCR 3584)

For serious spacecraft attitude control or other subsystem anomalies, a key feature of maintaining health and safety will be use of the Safe Hold Mode (SHM), which permits automated acquisition and long-term attitude control of the satellite in a power-positive and thermally safe condition while maintaining ground communication. Entry into SHM may be triggered by an event or condition detected autonomously onboard, or it may be commanded manually based on engineering assessment of a failure or degraded condition. Recovery to normal Earth-pointing or storage mode attitude from SHM would involve significant planning and engineering preparation.

Although flight system anomalies present the greatest threat to mission health and safety, ground segment anomalies traditionally comprise the great majority of interruptions in product data flow. Ground anomalies are analogous to satellite anomalies in that autonomous failure detection and isolation is performed by the Enterprise Management function, but operators are still responsible for ensuring proper correction of any system fault. Ground segment engineers will respond similarly to spacecraft engineers in the event of a significant problem.

5.9.7 Station Relocation

The longitude station of a satellite may be changed several times over the duration of the mission. Station relocation will occur, for instance, when a satellite is “drifted” from the 89.5 W check-out location to the 105 W storage location or when a satellite is moved from the storage location into one of the operational stations. A satellite may also be relocated from an operational station at the end of its operational mission for other use before it is decommissioned. Emergency station relocation may be required to replace a failed operational satellite and meet availability requirements.

Station relocation maneuvers are initiated by applying an East/West delta-v at an apsis to raise or lower the semi-major axis and induce a “drift” rate in geosynchronous longitude. When the desired station is approached, a roughly equal and opposite delta-v at the same apsis re-circularizes the orbit at the new location and stops the drift.

The GOES-R series spacecraft are capable of up to 2 emergency station relocation maneuvers at a longitude drift rate of 3 deg/day, and 3 drift maneuvers at a drift rate of 1 deg/day. INR specifications will be maintained at the 1 deg/day drift rate. However, downlink of X-band frequencies during the station drift may be restricted, so that imaging may not be possible during station relocation and no INR specifications may be applicable. The end-of-life orbit boost maneuver is included as a station relocation event for completeness. (CCR 3584)

Station relocation events include the following:

- From checkout location to an on-orbit storage location at a minimum of 1° shift/day
- From the on-orbit storage location to the operational station location at a minimum of 1° shift/day
- Three changes of operational station location while meeting Attitude Control System pointing performance specifications at a minimum of 1° shift/day
- Two emergency relocations at a minimum of 3° shift/day
- From the operational station location to end-of-life longitude at a minimum of 1° shift/day
- Boost from geostationary orbit at end-of-life longitude to end-of-life super-synchronous orbit with a perigee of no less than 300 km above geostationary altitude.

5.9.8 Storage Mode Activation/Reactivation

Activation of on-orbit storage mode consists of reconfiguring spacecraft and instrument components to the prescribed state for long-term storage and acquiring the storage mode attitude (if different from the normal Earth referenced mode). Reactivation of a satellite from storage mode to full operational state will entail acquisition of the normal Earth-pointing attitude control mode used for imaging, reconfiguration of bus subsystem and instrument components, and possibly an orbit maneuver for relocation to an operational longitude station. Normally this will be done when a satellite is called-up to replace a failed or decommissioned operational satellite, but reactivation may also occur periodically to test aliveness or to perform an orbit maneuver for stationkeeping management. A satellite stored as an operational spare must be activated and ready for full operations within 3 weeks of call-up. This interval does not include the period of station relocation. Both storage mode activation and reactivation are planned and executed as special operations. (CCR 3019A)

5.9.9 Eclipse

The GOES-R series spacecraft are designed to support full operations through the maximum geosynchronous eclipse duration of 72 minutes. Nominally, all instruments, with the exception of CCOR on GOES-U, will be capable of continuous operation through eclipse. No special spacecraft operations are required to accomplish the daily eclipse entry and exits, with the possible exception of commanding to accomplish battery charge management. The only instrument that will require special operations is CCOR, which will require knowledge of eclipse entry and exit times so that it can perform a special sequence of imaging just before eclipse entry, remain idle during eclipse, then a special sequence after eclipse exit. Seasonal reconfigurations such as for the thermal and electrical power subsystems may be required, but should not significantly affect operations. (CCR 3584)

5.9.10 Flight Software

Flight software is generally modified to correct errors found in the course of operations, respond to spacecraft on-orbit anomalies, or to increase performance. Standard procedures for software patches are developed and tested prior to launch. Prior to uploading a patch, all software patches are loaded to the Flight Software Development Environment (FSDE) and thoroughly tested in a flight-like environment. All uploads will be tested, loaded and integrated on a non-interference basis.

Under special circumstances, on-board software may be improved. Before new software loads are transmitted to the satellite, they will undergo rigorous test procedures similar to the standard procedures developed for patches.

All flight software (including current images and software patches) is carefully controlled under GS configuration management. As part of regular monitoring of flight software, the entire contents of the memory are periodically downloaded and verified.

5.9.11 End-of-Life Decommissioning

NOAA's policy for post-mission disposal of geosynchronous spacecraft complies with guidelines recommended by NASA to minimize risk of interference with continued use of the geosynchronous orbit resource. Sufficient propellant is budgeted for de-orbit boost of each GOES-R series satellite. The primary goals of the decommissioning process are to achieve a perigee of no less than 300 km above geosynchronous altitude and to ensure that no RF whatsoever is radiated after deactivation. The secondary goals are to consume as much propellant as feasible and to vent all pressurized volumes. All electro-mechanical systems should be powered off to preclude the possibility of destructive mechanical failure (such as reaction wheel over-speed). Finally, all charging should be removed from the batteries to minimize the possibility of uncontrolled overcharge and battery explosion.

5.10 INSTRUMENT OPERATIONS

The ABI and SUVI can operate either autonomously using programmable internal schedules, or interactively in response to a command sequence. Autonomous operations may be enabled, disabled, or interrupted by command. GLM, SEISS, EXIS and MAG operate autonomously without the need for frequent uploads or calibration commands.

In addition to their Normal Operating Modes, all of the GOES-R instruments support a series of Instrument Diagnostic, and Health and Safety modes, including an autonomous SAFE mode. The GOES-R instruments are designed to execute transitions between modes in such a manner as to prevent damage to the instrument, and report the present operating mode for each instrument in the housekeeping telemetry for that instrument. Housekeeping telemetry is transmitted in all powered instrument modes.

Flight software for the instruments is reprogrammable on orbit, and Computer Software Units (object code modules) are usable immediately after upload, without restart of the internal computer, or requiring completion of the entire software package upload. All on-board memory may be dumped to the ground system on command without disturbing normal operations of instrument data processing.

The ABI includes a set of algorithms to be executed by the ground system to perform radiometric calibration, navigation, co-registration, and resampling of the imagery onto a fixed reference coordinate system to meet instrument performance requirements for Level 1b product data. Other instruments have associated algorithms to produce products to specification.

5.10.1 ABI Operations

The ABI collects Earth scene data swath by swath in an East/West direction and builds the image from successive swaths in a North/South direction. The ABI is able to scan across the Sun at its normal scan rate two times within 30 seconds or less without interrupting normal imaging operations or sustaining damage, although performance may be degraded. While in Normal Operating Mode, the ABI concurrently acquires all secondary observations required to meet radiometric and INR requirements within the scan period allocated for primary imaging. When star-sensing is active, the scan pattern is autonomously adjusted to perform the necessary acquisition.

The ABI will be capable of the following imaging tasks:

- **Full Disk Imaging (FD)** – This task provides hemispheric coverage of the area up to 83° local zenith angle; however, radiometric performance requirements are met to 65° local zenith angle. The coverage rate is either 15 or 5 minutes depending on the instrument operating mode. The spatial resolution is 0.5 to 2 km at nadir across 16 discrete channels.
- **Mesoscale (MESO)** – This task provides better temporal resolution, but over a smaller area. The coverage rate is 1000 km x 1000 km in 30 seconds. The spatial resolution remains 0.5 to 2 km at nadir across 16 discrete channels.
- **Continental United States (CONUS)** – This task provides timely coverage over the continental US. The coverage area of 3000 km (N/S) x 5000 km (E/W) is performed every 5 minutes. The spatial resolution remains 0.5 to 2 km at nadir across 16 discrete channels.

ABI has three normal imaging modes: Mode 3, Mode 4, and Mode 6. Full spatial and spectral resolution is maintained for each mode. Frame completion times given for each mode include any other scan operation to maintain radiometric and INR requirements.

- **Mode 3 (Flex mode)** – This mode provides interwoven coverage across all 16 channels for a full disk image every 15 minutes, a CONUS image every 5 minutes, and mesoscale images located anywhere in the full disk every 30 seconds. A table of mesoscale capture coordinates must be uploaded to the instrument with the observation schedule. The ABI allows for two mesoscale regions to be time-shared. Note that Mode 3 will require interleaving scans of the different types to meet data latency requirements.
- **Mode 4 (Continuous Full Disk)** – Scan Mode 4 provides uninterrupted observation of the full disk across all 16 channels every 5 minutes, from which CONUS observations every five minutes can be extracted.
- **Mode 6 (Ten Minute Flex Mode)** – This mode provides interwoven coverage similar to mode 3 except a full disk image is generated every 10 minutes instead of every 15 minutes. A CONUS

image is also generated within five minutes and mesoscale images can be generated every 30 seconds. (CCR 3584)

Mode 3 mesoscale tasking is analogous to the legacy GOES 13-15 series imager Rapid Scan Operation (RSO) mode (but with frames sizes closer to the super-rapid scan schedule). While it is possible to design a system for automated direct tasking of mesoscale frames by users, control of the ABI Mode 3 is similar to the legacy RSO scheme, where the Senior Duty Meteorologist vets mesoscale requests from local NWS field service offices. However, efficiency and automation of the Mode 3 tasking process is increased over the legacy GOES level. Similarly, though the capability may eventually evolve to dynamically task ABI mesoscale scans via a closed-loop automated system (e.g. using image analysis to identify severe storm regions for ABI mesoscale scans), this advancement would be implemented only after considerable study and validation.(CCR 3584)

Regardless of which possible scan mode switching to optimize mesoscale data collection under particular conditions, the normal synoptic cadence of 5 min CONUS and 15 min full disk images is maintained. (CCR 3019A, CCR 3584)

Mode 6 ten-minute full disk images allows NOAA to match the full-disk scanning cadence of our international partners enabling nearly global advanced imager coverage every ten minutes. Ten-minute full disk imagery is critical to our National Weather Service Weather Forecast Offices, National Centers, and the Volcanic Ash Advisory Centers in monitoring hazardous weather conditions and providing additional information in observationally limited areas like over the oceans or in the mountains. The faster temporal cadence also improves aviation safety. (CCR 3584)

Integral parts of each scan mode are space and blackbody calibrations needed to meet radiometric performance requirements. These calibrations are included in the allocated time for each. All instruments operate concurrently and continuously with minimal downtime for housekeeping operations. The ABI exploits the “Operate-through” capability of the spacecraft bus for continuous imaging within specification during housekeeping activities and possibly orbit maneuvers. (CCR 3584)

No special “keep-out-zone” commanding is required for Sun or Moon avoidance in normal operations. The ABI is capable of scanning across the Earth limb with the Sun present in the FOV at the normal scan rate without damage, but onboard software will prevent direct Sun impingement during normal imaging operations with minimal loss of image data. Solar and lunar exclusion zones for star looks and space-look calibrations are automatically computed by the ABI flight software using onboard spacecraft ephemeris data. (CCR 3584)

5.10.2 GLM

The concept for the GLM is to perform much of the raw data processing on the ground, resulting in a raw data downlink rate of approximately 7.5 Mbps. On-orbit operational requirements are very limited for the GLM. Detector navigation is performed on the ground using spacecraft bus attitude solutions. No routine on-orbit calibration will be required. A large amount of the raw data processing is done to discriminate between true lightning events detector stimulation produced by charged particles, surface glint, or electronic noise-induced events. The flash false alarm probability will be less than 5% after processing. (CCR 3019A, CCR 3584)

Some operational characteristics of the GLM are:

- Continuous operation through eclipse periods
- Withstands sun in the field-of-view indefinitely without damage
- Autonomous background imaging (intensity of every detector element) once every 2.5 minutes, or upon ground command

GLM data reported for each lightning event includes geolocation of the event to 5 km accuracy, intensity of the detected event, and time of the event to an accuracy of 500 microseconds. (CCR 3584)

5.10.3 Space Weather and Solar Imaging

The SUVI, EXIS, SEISS, and MAG/GMAG operate and transmit data during eclipses and stationkeeping maneuvers. Each operates independently of the other instruments on the spacecraft bus. When operational, all instruments will be observing simultaneously and do not invoke different observing modes. It is possible that the SEISS and MAG/GMAG instruments may be operational during on-orbit storage to collect space environmental data from the storage location. This function will depend on the storage mode attitude control mode and the downlink antenna geometry. For CCOR (GOES-U only), no images will be taken during total solar eclipse periods. To compensate for the data gap, an increased number of images will be taken just before and after the eclipse period. (CCR 3584)

SEISS, SUVI, and EXIS calibrations vary by instrument. The solar-pointing instruments require periodic (no more than 4 times per year) off-pointing from the Sun by up to 15 deg to measure background. Sequential orthogonal slews across the solar disk (cruciform slews) will also be required for the SUVI and EXIS instruments, but these activities may be combined into a unified operation for the Sun-pointing platform suite and are required no more than 4 times per year. Initial on-orbit calibration of the magnetometer instrument offset bias (instrument plus spacecraft) may require successive large-angle (multi-rev) spacecraft rotation maneuvers. The magnetometer offset determination is a one-time calibration maneuver involving large angle attitude slews performed during the spacecraft post-launch test period in the vicinity of local noon. (CCR 3584)

CCOR (GOES-U) operational scenarios are yet to be developed, save for the infrequent solar off-pointing calibration maneuvers; the instrument should require minimal operational resources. (CCR 3584)

5.11 SCHEDULING / MISSION PLANNING

All routine and special operations commanding of the spacecraft and instruments will be performed using the scheduling (mission planning) process. In general, the daily payload schedule is routine and is much repeatable from day-to-day. This routine schedule may be planned at least 30 days in advance. Long term changes requiring a change in the whole structure of a routine daily schedule (i.e. changing the size of a standard frame or setting up a specific research imaging sequence) will require at least thirty days' notice. Limited short-term schedule changes can be made within an hour in response to anomalies or rapidly changing conditions. Scheduling will generate all orbit event predictions for the Mission Management function, including instrument or attitude sensor interference periods, acquisition data for MM and user antenna pointing, solar and lunar eclipses, and solar RFI. (CCR 3584)

The normal spacecraft and instrument scheduling cycle will produce command loads of 7+ days duration. This will support the 7-day autonomy requirement to continue acquiring and transmitting instrument raw data for ground processing and distribution in case command capability is interrupted. The 7-day command set may be updated by scheduling and uploaded daily to take advantage of updated prediction data or instrument tasks.

The mission planning function will also schedule tasks needed for flight operations, including routine housekeeping activities, orbit adjust maneuvers, and instrument calibrations. Operations that may interfere with primary instrument operations will be minimized to meet data availability requirements.

Mission planning will be largely automated. Authorized NWS users will normally make ABI mesoscale definition requests using a dedicated access point interface, but they will also be able to request tasking by direct contact (e.g. by e-mail) if necessary. These requests will be merged using the mission planning scheduler. The schedule will then be de-conflicted and a timeline generated. This timeline will take into account resource constraints.

5.12 INSTRUMENT TASKING

Instrument tasking is defined as the process used to acquire image or sounding measurements over a desired geographic region. The tasking process includes:

- The definition of routine synoptic image schedules by the NWS
- The definition of dynamic mesoscale frames by authorized NWS elements in response to severe weather forecast and warnings
- The planning and scheduling processes in the Mission Management function to build command sequences and uplink the real time or stored command loads to the instruments.

For the ABI, instrument tasking consists of routine and dynamic tasking.

5.12.1 Routine Instrument Tasking

Routine instrument tasking is part of the normal Mission Management scheduling process. It may include seasonal or diurnal frames based on probability of severe weather, or tasking by NWS center or field offices based on known or anticipated conditions (i.e. with lead-times greater than near-real time). For normal synoptic imaging, maintaining ABI instrument operations scheduling in fixed 15 minute time blocks provides a consistent source of data that can be measured across extended time periods. This consistency is highly predictable for scheduling secondary product delivery resources from all classes of users and re-users. The ABI 15 minute time block is compatible with either mode-4 or mode-3 instrument operations. In all cases the ABI provides CONUS coverage every 5 minutes. The consistency normalizes repeated image processes such as derived winds to have fixed scalar values. This attribute may also extend to longer term measurements such as time-of-day cloud pattern analyses.

5.12.2 Dynamic Instrument Tasking

Dynamic instrument tasking is defined for the ABI as the near-real time ad hoc definition of mode 3 mesoscale frames directed in response to changing meteorological conditions. Dynamic tasking may be manual or automated, but inherently involves some degree of automation even to implement manual requests, increasing operational efficiency and minimizing turn-around time. The Mission Management

function may include an interface to the GOES-R user Access Point for authorized organizations to request mesoscale scans in near-real time, to expedite the approval process, and to generate command schedules.

While the precise application of the ABI flex mode is not yet clear, it is expected that the capability of mode 3 dynamic tasking of mesoscale frames will be exploited by forecasters. Mode 3 dynamic tasking for the ABI may use the following methods:

- Manual forecasts, watches, and warnings by NWS regional centers or field offices
- Precursor conditions derived from NWP models
- Precursor conditions derived from GOES-R ABI, GLM, or eventually sounding products
- Precursor conditions derived from external Earth observation products (e.g. NPOESS or EOS products)

The third method presents the possibility for near real time automated processes implemented between GOES-R ground system functional elements (i.e. Mission Management and Product Generation).

The dynamic tasking concept may be extended to include Automated Instrument Scheduling (AIS). AIS uses autonomous processes by which mode changes or frame definitions are implemented using onboard logic within the instrument processors, or using ground-based tasking algorithms that derive local meteorological conditions from raw instrument data in near real time. An example of ground-based AIS for a mission that included an advanced Sounder would be use of atmospheric profiling observations acquired in a severe weather mesoscale sounding mode to direct ABI mesoscale frames along predicted severe weather fronts. Tasking involving direct commanding of the instrument to define a frame or operating mode will always be controlled through the GOES-R mission operations process. GOES-R will employ a phased, incremental approach to implement AIS – starting with limited dynamic tasking based on manual decision making, evolving towards more automated ground-based dynamic tasking as these concepts are demonstrated.

5.13 FLIGHT/GROUND INTEGRATED TEST PROGRAM

The GOES-R test program includes several types of integrated system tests between the satellite and operational ground system. These tests are supplementary to the segment-level tests necessary to validate planned operation of the Flight system and Ground system individually and as an integrated mission. (CCR 3019A)

5.13.1 Mission Operations End-To-End Tests

Since the pre-launch development effort of GOES-I in 1992, the GOES Program has prescribed a series of spacecraft-to-ground system End-To-End (ETE) test sequences for each satellite. ETE tests focus on the validation and compatibility of flight and ground hardware, software, and communications interfaces in a mission operations context. It is important to note that the ETE test program does not replace any aspect of segment level testing and should not be used at the Project level to fulfill segment level test

requirements². The ETE test program is intended to supplement the Project level V&V programs using “as flown” configurations and procedures.

For a detailed description of the ETE test program including scope and sequencing, see section 4.4.2 of the Program V&V Plan.

5.13.2 Special Integrated Tests

Other special system-level tests may be performed that require an integrated Flight and Ground system configuration. These validation tests are defined and executed in response to a need to mitigate specific mission risks. (CCR 3019A)

Mission Validation Testing (MVT)

The purpose of MVT is to flow flight like instrument data, ground ancillary data and spacecraft telemetry through the Ground system prior to launch in a true TLYF configuration, out to L1b and selected L2+ data products. For a detailed description of MVT, see section 4.4.1 of the Program V&V Plan. (CCR 3019A)

Radio Frequency Compatibility (RF Compat)

The purpose of RF Compat is to validate the design compatibility of new space-ground communications hardware through live broadcast testing early in the flight article assembly process. This is separated into two tiers of testing: Tier 1, the primary links (S/L/X) Band; and Tier 2, the auxiliary communication links (VHF/UHF). For a detailed description of RF Compatibility Tests, see section 4.4.3 of the Program V&V Plan. (CCR 3019A)

5.14 CALIBRATION AND VALIDATION

Calibration and validation ensures that raw instrument measurements are properly converted to meet accuracy and product quality requirements. GOES-R applies calibration and validation terminology to different processes in the data acquisition and production activities:

- Radiometric calibration refers to the process of converting and correcting raw detector measurements into science data units (e.g. radiance) with the specified level of accuracy.
- Geometric calibration refers to the accurate geolocation of instrument pixels using the INR process.
- The term “calibration” also refers to specific modes of instrument operation where, for instance, a calibration reference source (e.g. black body radiation source or cold space) is periodically sampled to derive calibration parameters dynamically in response to changing conditions or detector response.

² For instance, bandwidth limitation in the ETE test configuration may make it impractical to acquire instrument scene measurements and flow raw data through the entire Product Generation system to generate products in a real time “photons-to-products” test. This test would be conducted as a stand-alone Ground Segment system-level test using recorded raw data or other instrument data source.

- The phrase “calibration and validation” in the product data context refers to the system-level process of ensuring measurement and product accuracy, performed during the pre-launch and post-launch mission phases.

Instrument calibration modes are assumed to occur autonomously and do not require ground interaction other than to retrieve the measurements for use in the ground calibration and validation process. However, some instruments may require special calibrations that will interrupt normal data collection (e.g. solar off-pointing of the SUVI and EXIS). In the CONOPS context, calibration and validation mainly applies to the processing of instrument data in the Level 1b process. CCOR calibration is outside the scope of this document, as its data is processed by SWPC. (CCR 3584)

Calibration and Validation occurs over several phases of the mission:

5.14.1 Pre-Launch

Baseline data are obtained through factory testing. Parameters such as detector spectral response functions are determined and the instrument calibration database is developed. Instrument performance is measured under flight-like conditions. Pre-launch instrument calibration is the responsibility of the instrument developer, with government oversight. For a detailed description, see the Calibration/Validation Plan Volume 1. (CCR 3019A)

5.14.2 Post-launch Test Calibration

PLT calibration mainly occurs during SPOT. Specific test plans are executed to gather flight data to validate pre-launch calibration parameters and verify performance of the baseline Level 1b algorithms. Additionally, PLT includes a protracted arc of L1b and L2+ product validation beginning at SPOT and extending beyond the end of PLT, called Post-Launch Product Testing (PLPT). For detailed descriptions of calibration/validation plans for each product see Calibration/Validation Plan Volume 1 and Calibration/Validation Plan Volume 2. (CCR 3019A, CCR 3584)

5.14.3 Routine Operations Calibration

Routine operations calibration is the process of monitoring and maintaining Level 1b product performance within specification during sustaining operations. The system performs routine calibration and verification over the operational life of the mission. Routine calibration and validation activities include:

- Verifying conversion of raw detector samples to radiances and accuracy of the calibration database
- Trending detector noise
- Trending detector responsivity
- Trending instrument emissivity or other changes in radiometric properties
- Maintaining and contributing to ongoing analysis of other long-term calibration data such as calibration coefficients for the ABI solar-reflective channels, detector spectral response functions and regenerating detector radiance conversion coefficients based on changes in spectral response functions. (CCR 3019A)
- Verifying Level 1b product quality in both near-real time monitoring and non-real time analysis

Routine calibration of the SUVI, EXIS, and SEISS will be limited to autonomous function of the instrument, but will include periodic off-pointing of the solar platform by scheduled command. The GLM is not expected to have any routine calibration requirement. For CCOR on GOES-U only, there will be a SWFO Calibration Working Group (CWG) that will have SWPC, NCEI, and NRL representation. (CCR 3584)

5.15 IMAGE NAVIGATION AND REGISTRATION

Image Navigation and Registration (INR) is a set of image quality metrics pertaining to the location errors of Earth-referenced instrument pixels in Level-1b data. Navigation is absolute pixel location accuracy, and the various registration requirements specify relative pixel location accuracy. Within-frame registration and line-to-line registration are relative pixel-to-pixel location errors within a single frame. These errors result in image distortion and shear within a single image. Frame-to-frame registration is the relative motion of a given pixel in sequential frames. This error produces jumps when successive images are looped. Channel-to-channel registration is the offset between spectral channels for a given pixel location. These errors affect multi-spectral products derived from raw imagery.

INR requirements will be met through a coordination of all elements of the end-to-end system; the instruments, spacecraft, and ground processing system. INR processing will utilize precision onboard orbit solutions, star measurements made by the instrument, and spacecraft attitude and angular rate measurements together with ground-based resampling techniques to locate each pixel in a fixed-grid reference. Responsibility for meeting INR requirements, from photon collection through generation of Level-1b data, is placed on the instrument contractors (working to S/C-to-instrument interface pointing requirements met by the S/C manufacturer). This represents a departure from previous GOES series, in which INR was performed by the prime contractor (GOES I–M) and the spacecraft contractor (GOES N–Q).

Image navigation for the SUVI will involve all the spacecraft bus pointing considerations of the ABI, but with the additional complications of solar array platform-to-body dynamic interactions.

Body-fixed instruments such as the SEISS and MAG will be navigated via simple coordinate transformations using the spacecraft bus attitude estimate.

5.16 ALGORITHM DEVELOPMENT PROCESS

The Algorithm Development Process addresses the activities associated with GOES-R product algorithm development, implementation, and delivery. The general flow of algorithms and test data is from the Algorithm Working Group (in the case of L2+) or the GOES-R Program Office (in the case of L1b) to the Ground Segment Project (GSP); the GSP then delivers the algorithms and test data to the Ground Segment Contractor as Government furnished property. Specifically, the following paragraphs articulate the activities, services and data interchanges between the AWG, the GSP and GOES-R Program Office. This section first describes the development processes for L1b and L2+ algorithms and then outlines the delivery process for L2+ algorithms. CCOR algorithm development is outside the scope of this document as CCOR product generation beyond Level 0 is a responsibility of the SWFO program. (CCR 3584)

5.16.1 Level 1b Algorithm Development Process

The GOES-R instrument vendors develop, test and deliver the L1b algorithms to the GOES-R Flight Project/GOES-R Program Office in the form of Ground Processing Algorithm Documents (GPADs), along with the associated calibration coefficient database(s) and algorithm test data. The Flight Project/GOES-R Program Office verifies the GPADs prior to delivery to the GSP, which then provides them to the GS Contractor. The GS Contractor will implement the algorithms in software. The instrument vendors are responsible for calibration/validation through launch and available for long-term anomaly support beyond. (CCR 3019A)

The AWG will provide expertise, as requested by the GSP, to the instrument vendors and GS Contractor as necessary during L1b algorithm implementation and testing. Note that after GOES-R launch, the Calibration/Validation Working Group will assume the L1b Calibration/Validation lead role. The AWG will perform long-term drift correction employing lunar and stellar calibration activities for ABI, using defined ABI modes. The AWG will also provide Calibration/Validation support for the GLM and Space Weather Instruments under the auspices of the GOES-R Program Office.

5.16.2 Level 2+ Algorithm Development Process

The AWG will be responsible for technical leadership and management of L2+ algorithm development and algorithm Calibration/Validation, and the GOES-R GSP will provide monitoring, funding and approval of the scope of AWG activities. The main product delivered for each geophysical product by AWG development teams is an Algorithm Package in the form of an Algorithm Theoretical Basis Document (ATBD) and test data. ATBDs for each L2+ algorithm will be supplied to the GSP, and contain the following information:

- a. Changes from previous baseline versions of the algorithm
- b. Algorithm Overview
- c. Algorithm processing outline (logic flow, table of thresholds, flow chart packaging)
- d. Algorithm inputs (primary sensor and ancillary data)
- e. Theoretical description of the physics of the problem
- f. Mathematical description of the problem
- g. Description of the algorithm output
- h. Description of the test data sets covering the simulated/proxy input data sets, simulated/proxy output data sets, including precision & accuracy estimates and error budgets
- i. Practical considerations (e.g., numerical computation and programming/procedural considerations, quality assessment/diagnostics, and algorithm validation). Also a description of exception handling (e.g., bad data, missing data), including process for graceful degradation of product quality based on alternative inputs for ancillary data.
- j. Any assumptions made during development, including assumed algorithm and sensor performance and characteristics
- k. Limitations of the algorithm (and when the limitations are expected to be removed), e.g., does not meet accuracy, functions are degraded over scenes obscured by smoke
- l. References.

Test data will contain the following information:

- a. Proxy and simulated input/output test data sets

- b. Coefficient files
- c. Test programs/test information which contains test descriptions, plans and procedures, and performance testing results.

In addition to the Algorithm Package, the AWG will deliver to the GSP sample algorithm source code, related software development files such as program scripts, make files, and process control files, and software and installation documentation. Sample code will not have dependencies on COTS packages (e.g., IDL, McIDAS), will not be operational code, and will not be optimized for performance.

5.16.3 L2+ Algorithm Delivery Process

The AWG deliveries to the GSP will occur in four stages prior to GOES-R launch: initial through fourth delivery (which is completed approximately 4 years before launch), with a follow-on delivery after GOES-R launch. Three “maturity levels” are defined for the AWG L2+ algorithms: draft, 80% maturity, and 100% maturity. Algorithm maturity represents a metric of both the completeness of a data processing algorithm and associated verification tests.

The initial delivery will consist of all ATBDs at draft maturity; the second delivery will consist of all baseline Algorithm Packages at 80% maturity; the third delivery will consist of all baseline Algorithm Packages at 100% maturity, together with optional Algorithm Packages at 80% maturity. The fourth delivery will consist of all optional Algorithm Packages at 100% maturity. The follow-on delivery post-launch will consist of enhancements and/or deficiency corrections to algorithms and coefficient databases based on instrument flight performance and post-launch assessment and validation of L2+ products.

Note that the AWG may deliver to the GSP additional follow-on (maintenance) Algorithm Packages to be considered for implementation subsequent to the post-launch delivery. These follow-on Algorithm Package deliveries will contain minor algorithm modifications utilizing information from the instrument calibration activities (e.g. actual instrument response functions) to optimize algorithm performance or to correct deficiencies.

5.17 CONTINGENCY OPERATIONS

Contingency planning is fundamental to NOAA’s GOES-R operational philosophy, emphasizing health and safety of the satellite and continuous delivery of mission-critical data. The development of detailed Contingency Operations Procedures (COPs) is a key task of mission operations. COPs contain all steps necessary to place the spacecraft or payload into a safe condition in response to an anomaly. For anomalies that are covered by onboard autonomy (e.g. fault protection functions), COPs specify the resultant fault-protected state so that operators may verify proper function of the fault response and take corrective action if the response did not produce a safe condition. COPs will be developed jointly between the mission operations team (government and/or contractor) and the spacecraft and instrument vendors. Validation and rehearsal of contingency operations scenarios will be a primary pre-launch activity of the mission operations team. All real time operators and engineers will receive extensive training in contingency operations.

Spacecraft or instrument contingencies are detected by either direct observation of real time data by operators, spacecraft failure detection, identification by automated features of the ground system such as limit checking, or by offline trending of telemetry data. Identification of a possible contingency will

invoke the applicable COP, or in the case that the problem is not covered specifically by a COP, a prescribed general anomaly response flow will be initiated.

Ground system contingency planning will be addressed similarly to satellite contingencies. Ground COPs will be developed to ensure that critical Mission Management, Product Generation, and Product Distribution functions are maintained in the event that autonomous Enterprise Management response does not produce the expected result or does not cover a particular situation.

5.18 7-DAY AUTONOMY

GOES-R mission requirements include the capability for the satellite to operate autonomously for up to 7-days. The 7-day autonomy requirement protects against loss of command capability through either concurrent failure of both the WCDAS and remote backup site functionality (unlikely), failure of the satellite to receive or process commands, or through disruption of the command uplink (e.g. jamming of the command receiver). The autonomy requirement also ensures product data continuity in case problems with uplinks during ground segment fail-over scenarios produce gaps in coverage. The concept is that with no uplinks to the spacecraft whatsoever, accurate pointing and instrument operation would be maintained and raw data and telemetry would continue to be downlinked that could be processed and distributed terrestrially. The goal is to maintain the delivery of Key Performance Parameters through a period when command of the satellite is interrupted.

Although the preliminary requirement is that full performance specification be maintained up to 7 days, it is possible that some relaxation in INR performance may be allowed after 48 hours. This may be necessary to accommodate limited ABI parameter table storage capacity and growth in INR error as ground-generated compensation functions degrade over time. It is envisioned that onboard orbit knowledge will enable bus pointing to maintain full specification over the entire 7-day period.

5.19 CONTINUITY OF OPERATIONS

Continuity of system operations is a key requirement for the national critical GOES-R mission. The GOES-R system design fundamentally supports continuity of mission operations and data flow. As well as ensuring satellite health & safety, the 7-day autonomy requirement for continued satellite operation without ground support will provide continuous transmission of instrument raw data over short-term outages. Continuity of Operations requirements must ensure that ground elements are available for the production and distribution of key products. COOP requirements through the delivery of Level 1b Key Performance Parameter products meeting full specification are largely guaranteed by the design of the CBU, which will back up complete loss of either WCDAS or NSOF (or both). In less severe cases, for instance the temporary loss of a single element or function at a particular facility, the design will accommodate full continuity. Production of Level 2 and higher order products would not be covered by the CBU, but all KPPs, specifically the distribution of sectorized imagery to AWIPS, will be available. (CCR 1374, CCR 3019A)

COOP requirements are closely coupled to data availability requirements and to the overarching mission operations philosophy. GOES-R COOP planning encompasses not only facility backup plans and ground equipment/network configuration, but staffing and support elements. The goal is to design the system to operate continuously and independently without reliance on physical travel of personnel between sites (although this may occur eventually if a long outage is foreseen and circumstances permit safe travel).

Regular proficiency training exercises (e.g. weekly) will ensure the readiness of the NSOF and CBU facilities and staff for contingency fail-over operations. Periodic use of backup equipment (e.g. weekly), especially telemetry and command and GRB functions, will validate operational readiness of the CBU facility and components. At certain intervals (e.g. annually or semi-annually), full COOP deployment exercises may be conducted to rehearse scenarios and verify each functional element needed to support COOP requirements. (CCR 3019A)

Operational Failover

Figure 9 outlines several operational failover scenarios between the NSOF, WCDAS, and CBU on a functional basis. Four ground site availability cases are covered: (CCR 1558, CCR 3019A)

- Nominal case with both primary facilities (NSOF and WCDAS) and the backup (CBU) fully available (“up”)
- WCDAS unavailable (“down”) with NSOF and CBU up
- NSOF down with WCDAS and CBU up
- Both primary sites down with only CBU up

These cases assume that all site functionality or connectivity to a site is lost and do not cover partial functionality of particular sites. Site functionality is categorized as:

- Space/Ground communications (RF uplink and downlink)
- Satellite console operations
- Mission operations engineering, scheduling, software, and other off-line functions
- The production of Level 1b data and GRB relay
- The production of Level 2+ products
- The production and distribution of KPPs
- Enterprise Management primary control
- HRIT/EMWIN and DCS services
- The distribution of Level 2+ products via the GOES-R Access Point (CCR 1374)

	S/G Comm	Satellite Console Ops	Mission Ops Eng / Sch	L1b PG	GRB	L2+PG	KPPs	EM	HRIT / EMWIN	DCS	GOES-R Access Point (L2+PD)
W^N^R^ (nominal)	W	N	N	W	W	N	W	N	N/W	W	N
W, N^R^	R	N	N	R	R	N	R	N	N/R	↓***	N
W^N, R^	W	W	R*	W	W	↓	W	W	W**	W	↓
W, N, R^	R	R	R*	R	R	↓	R	R	R	↓***	↓

Figure 9: Ground Site Failover Scenario Matrix (CCR 1374, CCR 1558, CCR 2680A)

The letter assigned to each matrix element designates the GS site responsible for a function. In the case where the anticipated duration of an outage requires a full COOP deployment, NSOF-based mission operations support would move to CBU (indicated as *). Since HRIT data are created at the NSOF and relayed at either WCDAS or CBU, HRIT will contain whatever data is available in cases where the NSOF is down (indicated as **). For the cases where WCDAS is down, GOES-R DCS service would be unavailable, but DCS operations could be maintained independent of GOES-R via the DCS program backup (indicated as ***). For functions that are not backed-up (L2+ PG, and L2+ PD), availability is indicated as either up or down. (CCR 3019A)

Note that in the scenarios outlined here, failover is defined for broad functional categories. It may be efficient to failover certain activities on a more discrete basis (e.g. planning and scheduling only in the case of a discrete failure of the scheduling system at the primary site) depending on the implemented architecture. (CCR 1374)

5.20 GROUND SOFTWARE SUPPORT

The ground software support function is responsible for installing, monitoring, maintaining and upgrading all GOES-R ground software elements and databases. This function includes all IT and operational ground software. Software support also assures that software standards and procedures are followed, and applies appropriate configuration control of critical software.

The software support function is generally concentrated on monitoring and maintaining operations; however, software may also be developed to make the operations more efficient or to assimilate new IT. All operational software must follow standard development and configuration management practices. Defined software processes will be used and data will be collected on the performance of these processes. These data will then be used to improve software processes. Data collection and process

improvement is a continuous activity. New and upgraded scientific algorithms accepted by the AWG will be transitioned into operational software using the same rigorous techniques applied to the initial collection of operational algorithms available at IOC.

All ground software will be maintained by a dedicated GOES-R group. In the event of a problem at any site, the software group will be able to remotely access and inspect the affected component(s). The software group will be able to ingest data from the problematic components to assess anomalies. When a problem is resolved, the software group will be able to modify and test the code, and then distribute it to the appropriate portion of the system. All software development and maintenance will be performed with no interference to the operational system. This will require a development and test environment independent of operations, but reflecting the full operational configuration.

In the event of a software problem, it may be necessary to revert to backup software to maintain operations. All software backups will be stored at the CBU in addition to the NSOF. Potential software upgrades and new programs will be evaluated. When the decision is made to use either new or an upgraded version of software, the software will be tested prior to installation. Testing phases include development, acceptance, and parallel operations. No operational software will be introduced to the operational system until after it has been thoroughly tested using operational data in a high fidelity simulation environment. (CCR 3019A)

5.21 CONFIGURATION MANAGEMENT

Configuration management will be performed in accordance with the GOES-R Program Configuration Management Plan. Some specific functions included in the configuration management plan are:

- Configuration identification
- Configuration planning
- Configuration control
- Configuration audit
- Configuration verification
- Configuration status
- Audit reconciliation
- Document configuration control
- Problem reporting
- Change request process
- Engineering change notice process

Configuration management processes will be applied to software and hardware elements, as well as mission operations configured items. These processes will be automated to the maximum extent practical. (CCR 3584)

5.22 OPERATIONS TRAINING

A robust training program will be maintained throughout the mission lifetime to ensure safe and efficient mission operations and to ensure that GOES-R data users can fully access the data available to them. The training will include the following segments:

- Spacecraft and instrument engineering and operations

- All GOES-R routine and contingency operations
- Ground segment software maintenance
- Ground segment hardware maintenance

The training will take various forms, depending on the type of training. For example, operators will be trained in facilities that emulate the interfaces and simulate performance with high fidelity. Software and hardware maintenance personnel may receive training from vendors on specific programs or equipment. Users might be able to take synchronous teletraining, or might be able to receive web-based training, depending on their needs.

A training program will be in place to train and certify new operational staff members six months prior to launch. This training program will be used for regular operational staff refresher training and recertification.

Proficiency training exercises will be performed periodically to rehearse fail-over scenarios between NSOF, WCDAS, and CBU, and to verify functionality of the systems for contingency events. (CCR 3019A)

5.23 SECURITY

GOES-R mission security is comprehensive, encompassing all aspects of information technology, spacecraft command encryption, operational network control and access, and physical security.

The GOES-R system has been categorized in accordance with Federal Information Processing Standards (FIPS) Publication 199 as a Confidentiality Sensitivity of “Low,” an Integrity Sensitivity of “High,” and an Availability Sensitivity of “High.” GOES-R is therefore considered a *high-impact system*. GOES-R is also considered to be critical infrastructure according to Homeland Security Presidential Directive 7 (HSPD-7), *Critical Infrastructure Identification, Prioritization, and Protection*. Security requirements for the GOES-R system are also defined by the Department of Commerce IT Security Program Policy and Minimum Implementation Standards, and the NOAA IT Security Manual, NOAA-212-1301. Both the DOC and NOAA documents are consistent with federal guidelines and enforce FIPS 199 and 200.

In addition to the requirements listed above, the GOES-R system must enforce mission security according to the requirements defined in the MRD, especially the prevention of unauthorized access to command streams. The entire Ground Segment must successfully complete Authorization and Accreditation before acceptance by the government. (CCR 3019A)

6 APPENDIX: Data Storage and Archive Summary

Because data storage of several types occurs in various functional elements of the Ground Segment, the following table summarizes various data types within the GOES-R storage and archive structure:

Data Type	Duration	Element	Function
Engineering TLM	Life	MM	Engineering analysis; performance trending
Raw Data (Transfer Frames)	5 days	MM	Diagnostic
Events, CMD history	Life	MM	Engineering analysis; performance trending
Level 1b	7 days	PG	Product Distribution and Access
Instrument Calibration data	7 days	PG	Product Distribution and Access
Selected L2+	7 days	PG	Product Distribution and Access
L1b, L2+	Life	CLASS	Mission repository & stewardship
Selected products	Life	CLASS	Mission repository & stewardship
Ancillary Data	Life	CLASS	Mission repository & stewardship
Metadata	Life	CLASS	Mission repository & stewardship
Algorithms	Life	CLASS	Mission repository & stewardship
FSW, Ground software	Life	CLASS	Mission repository & stewardship

Table 3: Archive Summary (CCR 1374, CCR 3019A)

Engineering Data Storage

All engineering telemetry from the satellite will be stored for the life of the GOES-R program. This archive also includes event and command history data. The engineering data archive will serve the engineering analysis system for retrieval and display of spacecraft and instrument data. (CCR 1374)

5-day Revolving Temporary Storage

The 5-day revolving temporary storage of the Mission Management function will make raw data transfer frames available for diagnostic purposes in case engineering needs to troubleshoot an instrument or ground system problem with the data, or for research special request internal to the GOES-R program. (CCR 1374)

7-day Revolving Temporary Storage

The 7-day revolving temporary storage component of the PDA will serve as the basis for the retrieval of recent mission product data. This storage will contain the most recent 7-days for each instrument onboard GOES-R of all Level 1b, Level 2, and Level 2+ data produced by PG as well as instrument calibration data. Access to the 7-day archive will be via the GOES-R Access Point and will be limited to approved operational users to avoid ‘data thrashing’ through over-use by non-operational service requests. Non-approved users should be redirected to CLASS, as CLASS should be specified to not have any built in data accession delays. (CCR 1374, CCR 3019A)

CLASS Archive and Access Services (CCR 1374)

Permanent data archive and stewardship will be performed completely within CLASS. The specific data and products archive in CLASS will be defined by NOAA outside of the GOES-R program. However, it may include all Level1b data from all instruments, selected higher level products, algorithm source code, calibration parameters, etc. Other than the ESPDS PDA distribution of data to CLASS, all interaction with CLASS is considered outside of the GOES-R program scope.

7 GLOSSARY

Absolute Time Sequence - sequence of commands executed at the absolute time tag associated with each command in the sequence.

Archive & Access - capability for maintaining a record of all collected data, science algorithms, hardware and software designs, software source and object code, etc. over the life of the program; and providing indexing and retrieval capabilities.

Availability – The probability that a system can provide functionality meeting requirements. (CCR 1374)

BOL - Beginning-Of-Life defines the point in the mission life just after the satellite achieves its mission orbit altitude, when operational resources and functions are at their maximum (e.g., full propellant load, all components operating at full specification, etc.). (CCR 1374)

CONUS- Nadir-viewed rectangle 8.0215 x 4.8129 deg, 5000 km East/West x 3000 km North/South, approximately the geographic area of 15-55 N latitude and 50-115 W longitude (when collected from East and Central orbital positions) or 15-55 N latitude and 90-160 W longitude (when collected from West orbital position). (CCR-2886) (CCR 3019A)

Daily Operation - recurring nominal operations over a 24 hour period (CCR 1374)

End-to-End - For an operational system, this includes data gathering by the satellite payload and on-board payload processing for downlink, data ingest and preparation, together with ground telemetry processing, product generation and distribution within stated latency and performance constraints. For a sub-system element such as an instrument, ground MM or PG, initiates at the receipt of data through its precedent interface, through completion at the element level to its delivery interface. (CCR 1374)

EOL - End-Of-Life defines the point in the mission life where resources required to maintain operational specification have been effectively exhausted (e.g. propellant remaining only for de-orbit, components degraded, etc). (CCR 1374)

Full Disk (FD) - Defined as a 17.76 degree diameter circle centered at nadir, where 0.36 degree is added to the normal Earth diameter of 17.4 degrees for non ideal orbital characteristics and anticipated image motion.

Full Operational Capability (FOC) – Defines the event at which full availability requirements of both East and West operational stations are met exclusively with GOES-R series resources. (CCR 1374)

GOES Rebroadcast (GRB) – GOES-R Rebroadcast is relay of selected GOES-R data products through the satellite. This term is often used to refer to the product set being rebroadcast (CCR 1374).

GOES Variable (GVAR) – GOES Variable data format is the heritage GOES-I/P Level 1b retransmission data format and rebroadcast service. (CCR 1374)

Housekeeping – the set of activities or resources periodically invoked to maintain the satellite within mission-acceptable parameters and in a condition to provide full mission objectives. (CCR 1374)

Initial Operational Capability (IOC) - The event when the first GOES-R series mission has satisfactorily completed flight testing, and the complete flight and ground system has been verified as meeting all functional, performance, and availability requirements for a complete set of instruments at either the East or West operational stations. (CCR 1374)

Instrument – For GOES-R the instruments are: ABI, EXIS, GLM, Magnetometer, SEISS, and SUVI. (CCR 1374)

Key Performance Parameters (KPPs) – The minimum mission subset of products identified as critical to the protection of life and property. For GOES-R, the KPPs are cloud and moisture imagery. (CCR 1374)

Level 0 data – Reconstructed unprocessed instrument data at full resolution; any and all communications artifacts (e.g. synchronization frames, communications headers) removed. (CCR 1374)

Level 1a data – Level 0 data with all supplemental information appended for use in subsequent processing. (CCR 1374)

Level 1b data – Level 0 data with radiometric and geometric correction applied to produce parameters in physical units. (CCR 1374)

Level 2 data – Derived environmental variables (e.g. sea surface temperature) at a comparable temporal and spatial resolution to the Level 1 source. (CCR 1374)

Level 2+ - All level 2 and higher products. (CCR 1374)

Level 3 data – Data or retrieved environmental variables that have been spatially and/or temporally resampled (i.e. derived from Level 1 or 2). Such resampling may include averaging and compositing.

Level 4 data – Model output or results from analyses of lower level data (i.e. variable that is not directly measured by the instruments, but are derived from these measurements). (CCR 1374)

Mesoscale (MESO) – Defined as the equivalent of a 1.6043 x 1.6043 degree, 1000 x 1000 km nadir viewed area. (ABI PORD)

Mission – The full life cycle development and operation of a particular satellite. The Mission Phases are: Pre-launch, Launch and Orbit Raising, Post-Launch Test, Operations, Storage, and Disposal. (CCR 1374)

Mode – Manner of operation, use or existence of a system (CCR 1374)

Operational – A status designation that indicates readiness, capability, and authorization to support or conduct mission operations. Also a descriptive term to refer to something in an operations-like state or configuration. (CCR 1374)

Payload – An instrument or communications component mounted on the satellite that provides measurement data or communications service to fulfill mission goals.

Phase – Stage in the life cycle of a mission

Product – Derived data from the raw instrument measurements in a specific output format. Products may be classified as Level 0, Level 1, and Level 2+ depending on their degree of processing. (CCR 1374)

Pull – mode for data access in response to a user request where a user (or user environment, if automated) is notified of availability of data for pickup from a specific distribution server. Once notified, the user (or user environment) initiates a transfer of the data from a distribution server. (CCR 1374)

Push – mode for data access in compliance with a pre-established user agreement where a distribution server automatically sends data to a user environment without prior notification to the user. No explicit acknowledgement or request is required from the user or user environment.

Relative Time Sequence – sequence of commands executed from the on-board processor following a pre-defined sequence with time tags relative to the time the command sequence was initiated.

Satellite – the orbital system comprising the spacecraft bus, instruments, and any other payloads (CCR 1374)

Spacecraft – For GOES-R, the spacecraft consists of the spacecraft bus, auxiliary communication services payloads, and Magnetometer. (CCR 1374).

Special Operation - Activity to support maintenance of satellite functions or engineering and science investigation outside of normal, routinely scheduled operations.

State – condition of a system with respect to circumstances in the mission.

Subscription – A standing request for data or notification of data availability defined by user-specified criteria, to be delivered on a continuous or conditional basis. (CCR 1374)

User - A class of organizations that acquire GOES R data and products to support a mission, environmental assessment, or scientific research. (CCR 1374)

Yaw Flip – An attitude maneuver of the spacecraft 180 degrees about the nadir (yaw) axis that reverses the signs of pitch and roll relative to the orbit frame while maintaining yaw pointing at nadir. (CCR 1374)

8 ACRONYM LIST

A&O	Acquisition and Operations
ABI	Advanced Baseline Imager
ACT	Activation and Characterization Test
AFWA	Air Force Weather Agency
AIS	Automated Instrument Scheduling
APID	Application Process Identifier
ATBD	Algorithm Theoretical Basis Document
ATS	Absolute Time Sequence
AWC	Aviation Weather Center
AWG	Algorithm Working Group
AWIPS	Advanced Weather Interactive Processing System
CCSDS	Consultative Committee for Space Data Systems
CLASS	Comprehensive Large Array-data Stewardship System
CMD	Command
CBU	Consolidated BackUp
CCOR	Compact Coronagraph
COMSEC	Communications Security
CONOPS	Concept of Operations
CONUS	Continental United States
COOP	Continuity of Operations
COP	Contingency Operations Procedure
COTS	Commercial Off-The-Shelf
DAP	Delivered Algorithm Package
DCPI	Data Collection Platform Interrogation
DCPR	Data Collection Platform Report
DCS	Data Collection System
DOST	Data Operations Support Team
DSN	Deep Space Network
E	East
E/W	East West
EHIS	Energetic Heavy Ion Sensor
EM	Enterprise Management
EMC	Environmental Modeling Center
EMWIN	Emergency Managers Weather Information Network
ESPC	Environmental Satellite Processing Center
ESPDS	Environmental Satellite Processing and Distribution System
ETE	End-to-End
EUVS	Extreme Ultraviolet Sensor
EXIS	Extreme ultraviolet and X-ray Irradiance Sensor
FD	Full Disk
FDC	Fault Detection and Correction
FNMOCC	Fleet Numerical Meteorology and Oceanography Center
FOC	Full Operational Capability
FOV	Field of View`
FSDE	Flight Software Development Environment
FSW	Flight Software

GAS	GOES-R Access Subsystem (deprecated name for PDA)
GEOLUTs	Geostationary Earth Orbit Local User Terminals
GEOSS	Global Earth Observation System of Systems
GFI	Government Furnished Information
GOES	Geostationary Operational Environmental Satellite
GLM	Geostationary Lightning Mapper
GN&C	Guidance, Navigation and Control
GOES-R	Geostationary Operational Environmental Satellite-R series
GPAD	Ground Processing Algorithm Document
GRB	GOES Rebroadcast
GS	Ground Segment
GSP	Ground Segment Project
GVAR	GOES Variable Data (Legacy GOES)
H&S	Health and Safety
HPC	Hydrometeorological Prediction Center
HRIT	High Rate Information Transmission
I&T	Integration and Test
IDD	Internet Data Distribution
IDL	Interactive Data Language
IF	Intermediate Frequency
I/F	Interface
ILS	Integrated Logistics Support
INR	Image Navigation and Registration
IOC	Initial Operational Capability
IRD	Interface Requirements Document
IT	Information Technology
KPP	Key Performance Parameters
LCC	Life Cycle Cost
LOR	Launch and Orbit Raising
LUT	Local User Terminal
LV	Launch Vehicle
LZA	Local Zenith Angle
LZSS	Level Zero Storage Service
MAG	Magnetometer
McIDAS	Man-computer Interactive Data Access System
MM	Mission Management
MOM	Mission Operations Manager
MPS	Magnetospheric Particle Sensor
MRD	Mission Requirements Document
NASA	National Aeronautics and Space Administration
NAVOCEANO	Naval Oceanographic Office
NCEI	National Centers for Environmental Information
NCEP	Naval Maritime Forecast Center/Joint Typhoon Warning
NESDIS	National Environmental Satellite, Data, and Information Service
NHC	National Hurricane Center
NMFC/JTWC	Naval Maritime Forecast Center/Joint Typhoon Warning
NOAA	National Oceanic and Atmospheric Administration
NOS	National Ocean Service

N/S	North South
NSA	National Security Agency
NSOF	NOAA Satellite Operations Facility
NWP	Numerical Weather Prediction
NWS	National Weather Service
OAR	Office of Atmospheric Research
OD	Orbit Determination
OPC	Ocean Prediction Center
OPSCON	Operations Concept
ORTT&C	Orbit-Raising, Tracking, Telemetry & Command
OSGS	Office of Satellite Ground Services
OSPO	Office of Satellite and Product Operations
PD	Product Distribution
PDA	Product Distribution and Access
PDRR	Program Definition and Risk Reduction
PG	Product Generation
PLT	Post-Launch Test
PM	Product Monitor
RF	Radio Frequency
RTS	Relative Time Sequence
SARSAT	Search and Rescue Satellite Aided Tracking
S/C	Spacecraft
SEISS	Space Environmental In Situ Suite
SGPS	Solar and Galactic Proton Sensor
SHM	Safe Hold Mode
SOE	Sequence of Events
SOH	Satellite Operations Handbook
SPC	Storm Prediction Center
SPOT	System Performance and Operations Test
SRF	Spectral Response Function
STAR	Center for Satellite Applications and Research
SUVI	Solar Ultraviolet Imager
SW/M	Severe Weather / Mesoscale
SWFO	Space Weather Follow On
SWPC	Space Weather Prediction Center
SXI	Solar X-ray Imager
T&C	Telemetry and Command
TLM	Telemetry
TOM	Transition to Operations Manager
TPC	Tropical Prediction Center
UETS	User Education and Training Segment
UPS	Unique Payload Services
USF	User Services Functionality
V&V	Verification and Validation
W	West
WCDAS	Wallops Command and Data Acquisition Station
WFO	Weather Forecast Offices
WMO	World Meteorological Organization

Effective Date: June 16, 2020
Expiration Date: Five years from date of last change
Responsible Organization: GOES-R Program/Code 410

410-R-CONOPS-0008
Version 3.0

XUP	HRIT/EMWIN Uplink Processor
XRS	X-Ray Sensor

(CCR 3019A, CCR 3584)